

# on se mple le™



## Table of Contents

---

### General Information

Freight Policy.....	4	Warranty Statement .....	9
Customer's Own Material .....	5-6	Quality Statement.....	10
Open Line Laminate (OLL).....	7-8	Chair Features & Adjustments .....	11

---

### Seating

#### Stack

Arcozi Four-Leg .....	12
Arcozi Sled .....	12
Arcozi Bistro-Height.....	14

#### Guest

Arcozi Guest.....	13
Enclude Guest.....	17

#### Task

Arcozi Task.....	13
Arcozi Classroom.....	14
Enclude Basic Task.....	16
Enclude Deluxe Task.....	16

#### Conference

Enclude Conference .....	17
--------------------------	----

#### Stools

Arcozi Task Stool.....	13
Arcozi Bistro-Height.....	14
Enclude Multi-Purpose Stool .....	17

#### Lounge

Murj.....	18
-----------	----

---

### Tables

#### Multi-Purpose

Akord .....	20
Jibe .....	24

#### Flip & Nest

Akord Flip .....	20
------------------	----

#### Conference

Akord Conference.....	22
-----------------------	----

#### Cafe

Akord .....	22
-------------	----

#### Bar & Bistro

Jibe .....	24
------------	----

#### Specialty

Unyon .....	31-33
Modix.....	36-45

#### Table Accessories

Cord Management .....	23
Desk Screen .....	23
Modesty Panel.....	23
Power.....	23

---

## Workstations

### Desks

Akord .....	21
Modix .....	36-46

### Storage

Vybe .....	34
------------	----

### Accessories

Modesty Panel .....	23
Accend Monitor Lift .....	25
Desk Screen .....	26
Peg Board .....	34

---

## Storage

### Personal

Atytude .....	34
Cache .....	27-30
Mobee .....	34
Sphyr .....	34
Vybe .....	34

### Communal

Unyon .....	31-33
-------------	-------

---

## Ancillary

### Screens

Desk Screens .....	26
--------------------	----

### Organization

Peg Board .....	34
-----------------	----

### Lighting

Lulli .....	25
-------------	----

### Power

ConnecTrac .....	23
Table .....	23

### Ergonomics

Accend .....	25
--------------	----

### Seating

Mobile Chair Cart .....	25
-------------------------	----

### Waste & Recycling

Stroom .....	35
--------------	----

# Freight Policy

---

## EFFECTIVE JUNE, 2024

Free freight on all orders.

## MINIMUM ORDERS

No minimum order requirement, however, all orders must be placed in full carton quantities.

## Special routing request fees for LTL (Accessorial Charges):

- Call before Delivery - Included. Please specify at order entry.
- Lift Gate Assistance - \$125 for orders requiring a lift gate (no loading dock).
- Inside Delivery - \$50 for delivery to threshold only of first door.
  - Does not include put in place, un-carton, assembly, or trash removal.
  - Local restrictions may apply.
- Additional redelivery or storage charges may apply if special routing requests are not specified ahead of time and additional trips are required.
- Contact Customer Service at [info@onsemblesolutions.com](mailto:info@onsemblesolutions.com) for a quote on Expedited Service (guaranteed date and time of delivery), or larger volume orders or special services requested over 2,000 lbs. Onsemble is not responsible for issues or costs arising from carrier transit delays, missed delivery appointments, etc.

---

## Freight Damage

All shipments must be carefully inspected upon receipt by the assigned freight forwarder to ensure all items are in satisfactory condition before signing the bill of lading. If there is visible damage or shortage, it must be noted on the bill of lading. If not noted, we will be unable to file a claim with the carrier due to their policies. Visible damage or shortage must be reported within 24 hours of receipt of goods by the freight forwarder.

## ORDERING INSTRUCTIONS

For inquiries regarding the specification of COM materials applied to Onsemble made to order seating solutions, contact (info@onsemblesolutions.com).

**Step 1:** Retrieve the necessary Onsemble made-to-order seating COM form found on page 6.

**Step 2:** Along with a copy of the COM form, send a 12"x12" material sample to:

*909 4th St.*

*Milford IA, 51351.*

*Attention COM Receiving*

Please include the model number and quantity of products required. This will allow for accurate yardage estimates.

**Step 3:** Upon approval of the material, please order the appropriate yardage and ship to:

*909 4th St.*

*Milford IA, 51351.*

*Attention COM Receiving*

Ensure the Onsemble purchase order number is included with the ship to address.

**Step 4:** Purchase orders will be acknowledged with production ship date.

## THINGS TO KNOW

- All COM fabrics and vinyls must be approved by Onsemble and will not be scheduled for production until the entire yardage/square footage requirements have been received within the manufacturing facility.
- The COM approval process requires two business days to evaluate and process the 12"x12" material sample.
- Onsemble will not return excessive material. After 60 days from when the production order ships, any excess material will be recycled as part of our continued commitment to protecting the environment.
- Yardage requirements may vary based on several factors including:  
Applied fabric direction, size, and geometry of the Onsemble product, and scale or print pattern. Yardage requirements will be conveyed to you upon approval of the 12"x12" sample. It is important to provide the product model number and units within the COM submission form. Yardage calculations are based on 54" wide materials.
- There are no minimum product unit requirements or pricing upcharges. Production lead-times vary by product. Standard warranty provisions apply.

# Customer's Own Material - Approval Form

## CUSTOMER & PRODUCT INFORMATION

Date		Customer Account Number	
Dealer Name		Purchase Order Number	
Dealer Contact		Onsemble Order Number, if available	
Street Address		Onsemble Product Model Number	
City, State, Zip Code		Onsemble Product Quantity (units)	
Phone Number			

## TEXTILE INFORMATION

Mill		APPLICATION	
Fabric Color		Is there a desired top/bottom to the fabric? (YES/NO)	
Fabric Name/Number		Is the fabric a stripe or 2-color plaid? (YES/NO)	
Total Yardage Shipped			

## TEXTILE ORIENTATION

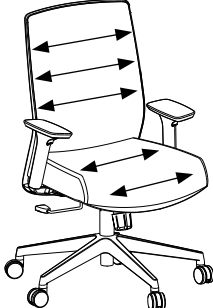
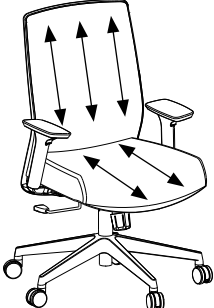
<p>Horizontal</p> <input type="checkbox"/>		<p>Vertical</p> <input type="checkbox"/>	
--	---	--	--

For customers requiring a specific laminate for tables, we offer open line laminate options.

## ORDERING INSTRUCTIONS

- Step 1:** Retrieve the necessary OLL form for specifying and placing orders from the next page.
- Step 2:** Complete the form with as much detail as possible and submit it to [info@onsemblesolutions.com](mailto:info@onsemblesolutions.com).
- Step 3:** We will review your submission within 5 business days and respond promptly with final list pricing.
- Step 4:** Purchase orders will be acknowledged and the production ship date will be provided.

## THINGS TO KNOW

- Open line laminate lead times typically range from 6-8 weeks, contingent on the HPL manufacturer and laminate availability.
- Onsemble will procure the specified and approved laminate in the required quantity of sheets to fulfill your project requirements.
- Due to standard laminate sheet sizes, laminates will be applied in a horizontal orientation unless otherwise specified.
- A \$75 net per table upcharge applies to Onsemble open line laminates.
- For open line laminate upcharges for 20 tables or more, and HPL laminates with special finishes or coatings, please contact [specials@onsemblesolutions.com](mailto:specials@onsemblesolutions.com).
- If you have any inquiries regarding special open line laminates, please email [info@onsemblesolutions.com](mailto:info@onsemblesolutions.com).

# Open Line Laminate (OLL) - Request Form

Return the completed form to [info@onsemblesolutions.com](mailto:info@onsemblesolutions.com)

## CUSTOMER & PROJECT INFORMATION

Date		Dealer Email	
Dealer Name		Customer Account No.	
Dealer Contact		Project Name	
Street Address		Install Date	
City, State, Zip Code		On-going Standards Program? Yes/No	
Phone Number			

## PRODUCT INFORMATION

Onsemble Model/Series Name	
Onsemble Model/Series Number(s)	
Quantity Requested	

## LAMINATE INFORMATION

Laminate Manufacturer	
Laminate Name	
Laminate Number	
Edge Band Name	
Edge Band Number	

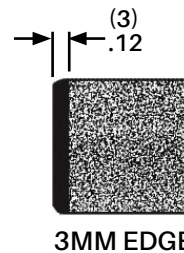

### Edge Band Options

- Black (F756)
- Designer Whiter (F582)
- Ice Gray (F755)
- Warm Gray (F754)
- Taupe (F753)
- Silver (F791)
- Medium Brown (F849)
- Dark Brown (F850)
- Raven-Charcoal (F851)
- Brick (F858)
- Other:

## ADDITIONAL PROJECT NOTES

1. Due to standard laminate sheet sizes, laminates will need to be applied in a horizontal orientation unless specified.
2. Onsemble open line laminates have a \$75 net per table up-charge.
3. Email [specials@onsemblesolutions.com](mailto:specials@onsemblesolutions.com) for open line laminate up-charges for 20 tables or more, and HPL laminates with special finishes.
4. For any questions about this form email [info@onsemblesolutions.com](mailto:info@onsemblesolutions.com).

Our warranty pledges excellence in the quality of our products. It helps protect our customer's investments and extends our continuing dedication to our customers after their initial investment.

## LIMITED LIFETIME WARRANTY

Onsemble® warranty obligation: We pledge to repair or replace, at Onsemble's option, any Onsemble product or component that is defective in material or workmanship for as long as you, the original purchaser, own it. This warranty is subject to the provisions below.

### LIABILITY LIMITATIONS

The following listed parts, components and supplies are covered under warranty in accordance with the below schedule following the product purchase date.

**Ten Years:** Seating controls and cylinders.

**Five Years:** Glides, casters, polymer-based components, seating upholstery (fabrics and leather), foam, armrests, chrome seating components, user-adjustable work surface mechanisms, laminates and other covering materials, drawer glides, electrical components, cabinets or mobile systems, components that are either moving parts or controls (guides that are in contact with moving parts).

**Three Years:** Outdoor Products, electrical components and Dry Erase Surfaces.

## WARRANTY SUBJECT TO EXCLUSIONS

Exclusions pertaining to this warranty are as follows but are not limited to:

- Normal wear and tear
- Product or product components utilized with the intent to rent or lease
- Freight damages: Onsemble is not liable for any product damages sustained during shipping or handling operations. Onsemble provides specific policies and requirements regarding shipping and handling, and reserves the right to review and address product distribution matters separately.
- Product negligence: A product is not considered defective due to misuse or improper installation. Onsemble products must be installed, used and maintained
- in accordance with product instructions and warnings.
- Alterations or attachments to the product that were not approved by Onsemble
- All COM Fabric is not covered under this warranty
- All corrugated products or components
- Use of non-multiple shift products for multiple shifts
- Products purchased through a discontinued products promotion/liquidation

Onsemble's warranty obligation is limited to normal use upon receipt of our products.

### SEATING USAGE

Normal commercial usage for seating is defined as the equivalent of a single shift, forty (40) hour work week. To the extent that a seating product is used in a manner exceeding this, the applicable warranty period will be reduced in a pro-rata manner.

## WARRANTY PROCEDURES

Please follow the warranty procedures described below:

1. Once a defect has been discovered, the original purchaser must contact Onsemble® immediately (within 30 days of defect detection), in writing, with the serial number(s) (if applicable), date code and model number from the product(s) in question.
2. Upon inspection of the product(s), Onsemble® will collect all relevant information necessary for review of the request.
3. Product replacement and replacement parts will be authorized by a Customer Care representative if acknowledged to be necessary under product warranty eligibility conditions.

## SPECIFIC LIMITATIONS REGARDING COLOR VARIATIONS, FABRICS AND FINISHES

Natural products have varying grains and colors. Due to such natural variations occurring in materials such as wood and leather, these characteristics are not considered defects. Onsemble does not warrant the color-fastness or matching of colors, grains or textures of such materials. Materials supplied, selected or provided by the customer (COM) are not warranted.

Buyer is responsible for freight to and from factory on all warranty claims. Any description of the goods sold hereunder, including any reference to Buyer's specifications and any description in catalogs, circulars and other written or digital material published by Onsemble is for the sole purpose of identifying goods and shall not create an express or implied warranty that the goods shall conform to such description.

THERE ARE NO OTHER WARRANTIES, AND Onsemble DISCLAIMS ALL IMPLIED WARRANTIES INCLUDING WARRANTIES OF MERCHANTABILITY, FITNESS FOR A PARTICULAR PURPOSE AND FREEDOM FROM PATENT INFRINGEMENT. NO AGENT, EMPLOYEE OR REPRESENTATIVE OF Onsemble HAS ANY AUTHORITY TO BIND Onsemble TO ANY AFFIRMATION, REPRESENTATION OR WARRANTY EXCEPT AS STATED HEREIN.

Onsemble SHALL HAVE NO LIABILITY FOR INDIRECT, INCIDENTAL, CONSEQUENTIAL OR SPECIAL DAMAGES OF ANY KIND. THESE LIMITATIONS ARE AGREED ALLOCATIONS OF RISK. UNDER NO CIRCUMSTANCES SHALL Onsemble's LIABILITY WITH REGARD TO THE SALE OR USE OF THE PRODUCTS EXCEED THE PURCHASE PRICE PAID BY THE BUYER FOR THE PRODUCTS. TERMS AND CONDITIONS OF THIS WARRANTY ARE SUBJECT TO CHANGE WITHOUT NOTICE.

Note: Onsemble® does not require the customer to fill out a warranty registration card. Please keep all purchase documents for the product in event the warranty is needed. Contact our Customer Care team for any warranty assistance at [info@onsembleproducts.com](mailto:info@onsembleproducts.com) or (877) 835-2935.

## STATEMENT OF QUALITY

At Onsemble®, we understand that quality extends beyond simple function, and we are committed to the highest level of satisfaction in the manufacture, sale, and support of our products. From concept to delivery, we integrate high levels of quality as our standard and work hard to impress our customers every day. We strive for continuous improvements in all areas of product and service by regarding our quality programs as an integral part of the company's improvement process. Onsemble's quality program works to provide products that meet or exceed the quality standards our customers expect. We aim to set high environmental and safety standards by offering a large collection of third-party tested products that meet standards set forth by BIFMA, UL, the State of California, and others.

## PROP 65 WARNINGS

Products with this icon  are subject to California Proposition 65. Please visit the product detail page on our website for specific information.

## ENVIRONMENTAL COMMITMENTS

Onsemble not only holds itself to strict environmental standards, but we also require suppliers to follow these standards as a total supply chain initiative. Suppliers play an important role in our longstanding commitment to perform operations in a manner consistent with sound health, safety, and environmental management practices. Because of this, suppliers are not only expected to comply with applicable health, safety and environmental laws and regulations, they are expected to seek continuous improvement within these realms.

Onsemble continues to become an environmentally conscious company with the intention to offer more products that our customers can feel good about, and responsible practices that encourage sustainability, helping us obtain a proud standing in our community and the planet.

## OPERATIONS

Onsemble advocates continuous improvement in the realms of efficient recycling and/or disposal of waste materials and improving treatment and control of waste emissions affecting air, water, and soil. We also encourage the practice of waste reduction operations such as machine efficiency, raw material utilization, conservation of soil, air, water quality, biodiversity, wildlife and aquatic habitats, the practice of sustainable forest management policies where applicable, end-of-life treatment recommendations, raw material and recycled content regulation, and legal compliance with environmental legislation.

## DESIGN

We reserve the right to make changes in design and material, as well as discontinuance of parts and units, when such action is deemed to be an improvement in design, function and/or construction.

## THE FOLLOWING ICONS ARE USED THROUGHOUT THIS PUBLICATION:



Shippable by  
Small Package Carrier



PROP 65 Warning



Meets ANSI/BIFMA  
Standards



Made in USA



## Seat Height Adjustment

Quick and easy adjustment regulates height of chair relative to the floor.



## Seat Glide Mechanism

Seat cushion travels forward and back, then locks into position.

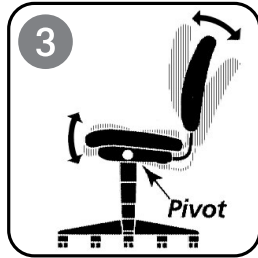

## Weight Sensitive Mechanism

Adjusts seat and back angles by sensing the user's body weight and reclines accordingly.

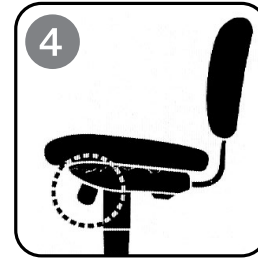

## Tilt Tension

Controls rate and ease with which chair reclines to different weight and strength of users.

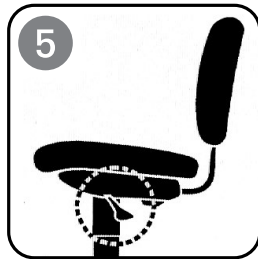

## Tilt Lock

Locks tilt function when chair is in upright position.

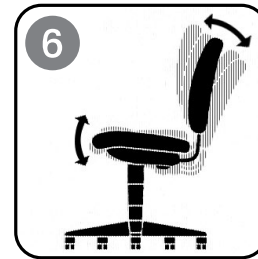

## Asynchronous Control

Three levers modify:

1. Angle of back relative to seat
2. Tilt (free float or infinite locking within a fixed range)
3. Forward tilt (for keyboard intensive applications)



## Integral Lumbar Support

Easily adjust to enhance comfort.

There are many features to consider when selecting the perfect chair to suit your needs. The following symbols will help you choose the features that are right for you. These symbols are used throughout this pricer to help quickly identify each chair's features. The descriptions of the features shown are meant to be general explanations. The actual functions of the features may vary slightly between chair series.

# Arcozi Seating Collection

ARCOZI

## Poly Options

Back & Lower Back/Seat Color Options

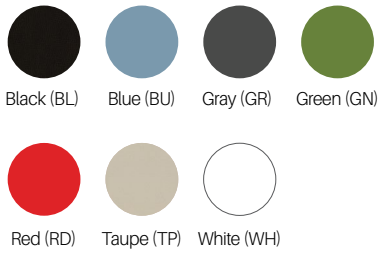

Shell Color Option Not Available. WH Only.



White (WH)

## Frame Options

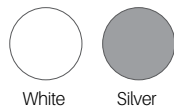

## Fabric Options

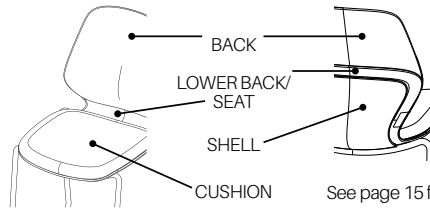

See page 15 for more chair details.



Parent #	Description	Color	Model #	List Price Ea.	List Carton Price	Quantity Per Carton
ACZ4LG	Arcozi 4 Leg Stack Chair Seat Height: 19" Chair Overall: 20.75"W x 22.25"D x 34.5"H	All Poly	ACZ4LGP	416.00	832.00	2
		Upholstered	ACZ4LGU	550.00	1,100.00	2

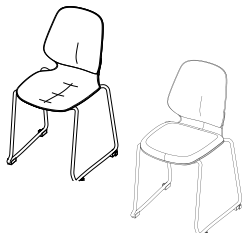

Parent #	Description	Color	Model #	List Price Ea.	List Carton Price	Quantity Per Carton
ACZSLD	Arcozi Sled Base Stack Chair Seat Height: 21" Chair Overall: 21.75"W x 21.75"D x 36.5"H	All Poly	ACZSLDP	433.50	867.00	2
		Upholstered	ACZSLDU	567.00	1,134.00	2

Parent	Back Color	Seat Color	Upholstered Seat	Frame Color
ACZ4LGP - 4 Leg Stack Poly ACZ4LGU - 4 Leg Stack Uph. ACZSLDP - Sled Base Stack Poly ACZSLDU - Sled Base Stack Uph.	BL - Black BU - Blue GN - Green GR - Gray	RD - Red TP - Taupe WH - White	BL - Black BU - Blue GN - Green GR - Gray	RD - Red TP - Taupe WH - White
			See above for Fabric Options	SL-Silver WH-White
			*for All Poly, leave blank	
<b>Example:</b> ACZ4LGP +	BU +	BU +	OR18 +	SL
<b>Model Number</b>	<b>Configured Options</b>			

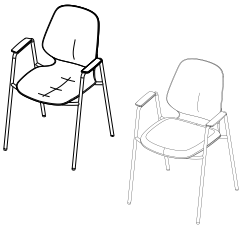

Parent #	Description	Material	Model #	List Price
ACZGCH	Arcozi Guest Chair Seat Height: 19" Chair Overall: 23.25"W x 22.25"D x 34.5"H	All Poly	ACZGCHP	551.00
		Upholstered	ACZGCHU	684.00

Parent	Back Color	Seat Color	Upholstered Seat	Frame Color	
ACZGCHP - Arcozi Guest Chair Poly ACZGCHU - Arcozi Guest Chair Uph.	BL - Black BU - Blue GN - Green GR - Gray	RD - Red TP - Taupe WH - White	BL - Black RD - Red BU - Blue TP - Taupe GN - Green WH - White GR - Gray	See page page 12 for Fabric Options *for All Poly, leave blank	SL-Silver WH-White
<b>Example:</b> A C Z G C H P +	B U +	B U +	O R 1 8 +	S L	
<b>Model Number</b>	<b>Configured Options</b>				



Parent #	Description	Material	Model #	List Price
ACZTCH	Arcozi Task Chair Seat Height: 17-22" Chair Overall: 30.5"W x 30.5"D x 33-38"H	All Poly	ACZTCHP	718.00
		Upholstered	ACZTCHU	852.00

Option	Upcharge
Seat Poly Color	N/C
Back Poly Color	N/C
Add Arms	122.00
Standard Caster	N/C
Hard Floor Caster	N/C
Hard Floor Premium	106.00
Glides	N/C



Parent #	Description	Material	Model #	List Price
ACZTST	Arcozi Task Stool Seat Height: 22.25-32.25" Chair Overall: 30.5"W x 30.5"D x 38-48"H	All Poly	ACZTSTP	868.00
		Upholstered	ACZTSTU	1,002.00



Option	Upcharge
Seat Poly Color	N/C
Back Poly Color	N/C
Add Arms	122.00
Standard Caster	N/C
Hard Floor Caster	N/C
Hard Floor Premium	106.00
Glides	N/C

Parent	Back Color	Seat Color	Upholstered Fabric	Arms	Casters or Glides	
ACZTCHP - Task Chair Poly ACZTCHU - Task Chair Uph. ACZTSTP - Task Stool Poly ACZTSTU - Task Stool Uph	BL-Black BU-Blue GN-Green GR-Gray	RD-Red TP-Taupe WH-White	BL-Black RD-Red BU-Blue TP-Taupe GN-Green WH-White GR-Gray	See page 12 for Fabric Options *for All Poly, leave blank	AL-Armless WA-With Arms	ST-Standard Caster HF-Hard Floor HFP-Hard Floor Premium GL-Glides
<b>Example:</b> A C Z T C H P +	B L +	B U +	O R 1 8 +	A L +	H F	
<b>Model Number</b>	<b>Configured Options</b>					

# Arcozi Seating Collection

ARCOZI

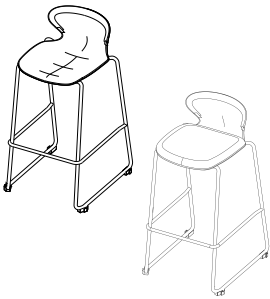

Parent #	Description	Color	Model #	List Price Ea.	List Carton Price	Quantity Per Carton
ACZBST	Arcozi Bar Height Stool	All Poly	ACZBSTP	700.50	1,401.00	2
		Upholstered	ACZBSTU	835.00	1,670.00	2
	Seat Height: 33" Chair Overall: 21.5"W x 24"D x 40.75"H					

Parent	Seat Color	Upholstered Fabric	Frame Color
ACZBSTP - Arcozi Bar Height Chair Poly ACZBSTU - Arcozi Bar Height Chair Uph	BL-Black BU-Blue GN-Green GR-Gray	RD-Red TP-Taupe WH-White	SL-Silver WH-White
	See page 12 for Fabric Options		
	*for All Poly, leave blank		
<b>Example:</b>			
<u>A</u> <u>C</u> <u>Z</u> <u>B</u> <u>S</u> <u>T</u> <u>P</u> +	<u>B</u> <u>U</u> +	<u>O</u> <u>R</u> <u>1</u> <u>8</u> +	<u>S</u> <u>L</u>
<b>Model Number</b>	<b>Configured Options</b>		



Parent #	Description	Color	Model #	List Price
ACZECH	Arcozi Education Chair	All Poly	ACZECHP	1,132.00
		Upholstered	ACZECHU	1,267.00
	Seat Height: 18.75" Chair Overall: 31.5"W x 26"D x 33.75"H			



Accessory	Charge
Universal Tablet Arm	Subtract \$122 from price for No Tablet

Parent	Back Color	Seat Color	Upholstered Fabric	Frame Color	Casters or Glides	Tablet Choice	Tablet Color	
ACZECHP - Arcozi Education Chair Poly ACZECHU - Arcozi Education Chair Uph.	BL-Black BU-Blue GN-Green GR-Gray	RD-Red TP-Taupe WH-White	BL-Black BU-Blue GN-Green GR-Gray	RD-Red TP-Taupe WH-White	SL-Silver WH-White	CA-Casters GL-Glides	WT-With Tablet NT-No Tablet	BL-Black WH-White
	See page 12 for Fabric Options							
	*for All Poly, leave blank							
<b>Example:</b>								
<u>A</u> <u>C</u> <u>Z</u> <u>E</u> <u>C</u> <u>H</u> <u>P</u> +	<u>B</u> <u>L</u> +	<u>B</u> <u>U</u> +	<u>O</u> <u>R</u> <u>1</u> <u>8</u> +	<u>S</u> <u>L</u> +	<u>C</u> <u>A</u> +	<u>W</u> <u>T</u> +	<u>B</u> <u>L</u>	
<b>Model Number</b>	<b>Configured Options</b>							

- A. Back
- B. Lower Back Seat
- C. Shell
- D. Cushion (optional)
- E. Arm Pads
- F. Frame
- G. Glides
- H. Ganging Glides
- I. Arms
- J. Piston
- K. Cylinder
- L. Foot Ring
- M. 5-Star Base
- N. Casters
- O. Tablet
- P. Tablet Arm with Built-In Drink Holder
- Q. Base Shelf

<p><b>Chair Details</b></p>	<p><b>Stack Chair (4-Leg)</b></p>
<p><b>Stack Chair (Sled Base)</b></p>	<p><b>Guest Chair</b></p>
<p><b>Bistro Chair</b></p>	<p><b>Task Chair</b></p>
<p><b>Extended-Height Chair</b></p>	<p><b>Education Chair</b></p>

# Enclude Seating Collection

ENCLUDE

## Mesh Options

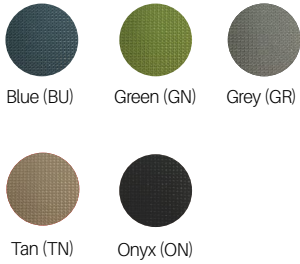

## Fabric Options



Parent #	Description	Model #	List Price
ECLTCHU	Enclude Task Chair <b>1 2 4 7</b> *	ECLTCHU	1,027.00
	Seat Height: 18"- 22" Seat: 18"W x 18"D Back: 17.5"W x 18.5"H Overall : 25"W x 25"D x 34.5"- 38"H		

Option	Upcharge
Basic Mechanism	N/C
Deluxe Mechanism	354.00
Headrest	112.00
Standard Caster	N/C
Hard Floor Caster	N/C
Hard Floor Premium	110.00
Glides	N/C

Parent	Back Mesh	Seat Fabric	Headrest	Headrest Fabric	Mechanism	Casters or Glides
ECLTCHU	BU - Blue Mesh GN - Green Mesh GR - Gray Mesh ON - Onyx Mesh TN - Tan Mesh	See above for Fabric Options	N - Without Headrest Y - With Headrest	See above for Fabric Options  *for no headrest, leave blank	BM - Basic Mech ST - Deluxe Side-Tension Mech	ST - Standard Carpet HF - Hard Floor HFP - Hard Floor Premium GL - Glides
Example: ECLTCHU+	<u>B</u> <u>U</u> +	<u>O</u> <u>R</u> <u>1</u> <u>3</u> +	<u>Y</u> +	<u>O</u> <u>R</u> <u>1</u> <u>3</u> +	<u>S</u> <u>T</u> +	<u>H</u> <u>F</u> <u>P</u>
<b>Model Number</b>	<b>Configured Options</b>					

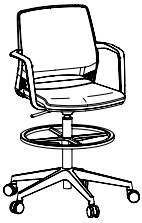

Parent #	Description	Model #	List Price										
ECLMSTU	<b>Enclude Multi-Purpose Stool</b> ⓘ *	ECLMSTU	1,087.00										
	Seat Height: 23"-33" Seat: 18"W x 18"D Back: 18"W x 18"H Overall: 28"W x 28"D x 38"-48"H												
	<table border="1"> <thead> <tr> <th>Option</th> <th>Upcharge</th> </tr> </thead> <tbody> <tr> <td>Standard Caster</td> <td>N/C</td> </tr> <tr> <td>Hard Floor Caster</td> <td>N/C</td> </tr> <tr> <td>Hard Floor Premium Glides</td> <td>110.00</td> </tr> <tr> <td></td> <td>N/C</td> </tr> </tbody> </table>	Option	Upcharge	Standard Caster	N/C	Hard Floor Caster	N/C	Hard Floor Premium Glides	110.00		N/C		
Option	Upcharge												
Standard Caster	N/C												
Hard Floor Caster	N/C												
Hard Floor Premium Glides	110.00												
	N/C												

Parent	Back Mesh	Seat Fabric	Casters or Glides
ECLMSTU	BU - Blue Mesh    ON - Onyx Mesh GN - Green Mesh    TN - Tan Mesh GR - Gray Mesh	See page 16 for Fabric Options	ST - Standard Carpet    HFP - Hard Floor Premium HF - Hard Floor            GL - Glides
Example:	<u>  </u> <u>  </u> +	<u>  </u> <u>  </u> <u>  </u> +	<u>  </u> <u>  </u> <u>  </u>
<b>Model Number</b>	<b>Configured Options</b>		



Parent #	Description	Model #	List Price										
ECLMCHU	<b>Enclude Multi-Purpose Chair</b> ⓘ *	ECLMCHU	936.00										
	Seat Height: 17"-22" Seat: 18"W x 18"D Back: 18"W x 18"H Overall: 28"W x 28"D x 32"-37"H												
	<table border="1"> <thead> <tr> <th>Option</th> <th>Upcharge</th> </tr> </thead> <tbody> <tr> <td>Standard Caster</td> <td>N/C</td> </tr> <tr> <td>Hard Floor Caster</td> <td>N/C</td> </tr> <tr> <td>Hard Floor Premium Glides</td> <td>110.00</td> </tr> <tr> <td></td> <td>N/C</td> </tr> </tbody> </table>	Option	Upcharge	Standard Caster	N/C	Hard Floor Caster	N/C	Hard Floor Premium Glides	110.00		N/C		
Option	Upcharge												
Standard Caster	N/C												
Hard Floor Caster	N/C												
Hard Floor Premium Glides	110.00												
	N/C												

Parent	Back Mesh	Seat Fabric	Casters or Glides
ECLMCHU	BU - Blue Mesh    ON - Onyx Mesh GN - Green Mesh    TN - Tan Mesh GR - Gray Mesh	See page 16 for Fabric Options	ST - Standard Carpet    HFP - Hard Floor Premium HF - Hard Floor            GL - Glides
Example:	<u>  </u> <u>  </u> +	<u>  </u> <u>  </u> <u>  </u> +	<u>  </u> <u>  </u> <u>  </u>
<b>Model Number</b>	<b>Configured Options</b>		

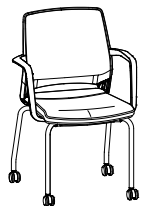

Parent #	Description	Color	Model #	List Price Ea.	List Carton Price	Quantity Per Carton										
ECLGCHU	<b>Enclude Guest Chair 2/CTN</b> ⓘ *	Black Frame	ECLGCHU	1,434.00	1,434.00	2										
	Seat Height: 18" Seat: 18"W x 18"D Back: 18"W x 18"H Overall: 23.5"W x 23.5"D x 33.5"H															
	<table border="1"> <thead> <tr> <th>Option</th> <th>Upcharge</th> </tr> </thead> <tbody> <tr> <td>Standard Caster</td> <td>N/C</td> </tr> <tr> <td>Hard Floor Caster</td> <td>N/C</td> </tr> <tr> <td>Hard Floor Premium Glides</td> <td>110.00</td> </tr> <tr> <td></td> <td>N/C</td> </tr> </tbody> </table>	Option	Upcharge	Standard Caster	N/C	Hard Floor Caster	N/C	Hard Floor Premium Glides	110.00		N/C					
Option	Upcharge															
Standard Caster	N/C															
Hard Floor Caster	N/C															
Hard Floor Premium Glides	110.00															
	N/C															

Parent	Back Mesh	Seat Fabric	Casters or Glides
ECLGCHU	BU - Blue Mesh    ON - Onyx Mesh GN - Green Mesh    TN - Tan Mesh GR - Gray Mesh	See page 16 for Fabric Options	ST - Standard Carpet    HFP - Hard Floor Premium HF - Hard Floor            GL - Glides
Example:	<u>  </u> <u>  </u> +	<u>  </u> <u>  </u> <u>  </u> +	<u>  </u> <u>  </u> <u>  </u>
<b>Model Number</b>	<b>Configured Options</b>		

# Murj Lounge Collection

MURJ

## Fabric Options



Platinum (DT15)  
Fabric



Slate (DT16)  
Fabric

## Leg Options



Black (BL)



Taupe (DT08)  
Fabric



Asian Night (ASNT)  
HPL



Battleship (BTTL)  
HPL



Biltmore Cherry (BMCH)  
HPL



Black (BLAK)  
HPL



Carbon Mesh (CARM)  
HPL



Columbian Walnut (CLWN)  
HPL



Designer White (DSWT)  
HPL



Fashion Gray (FNGY)  
HPL



Field Elm (FLEL)  
HPL



Fusion Maple (FUMP)  
HPL



Landmark Wood (LDMK)  
HPL



Pepperdust (PPDS)  
HPL



Pinnacle Walnut (PNWN)  
HPL



Portico Teak (PRTK)  
HPL



River Cherry (RVCH)  
HPL



Open Line Laminate

## HPL Laminate + Matching Edge Color Option

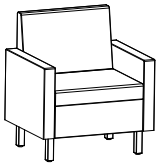

Parent #	Description	Model #	List Price
MRJLGBU	<b>Murj Lounge Chair, Both Arms</b>  Seat: 24"W x 19"D x 18.5"H Back: 24"W x 15.25"H Arm: 6"H Overall: 30"W x 24"D x 33.75"H	MRJLGBU	1,793.00

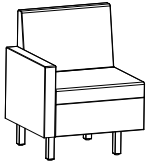

Parent #	Description	Model #	List Price
MRJLGRU	<b>Murj Lounge Chair, Right Arm</b>  Seat: 24"W x 19"D x 18.5"H Back: 24"W x 15.25"H Arm: 6"H Overall: 27"W x 24"D x 33.75"H	MRJLGRU	1,658.00

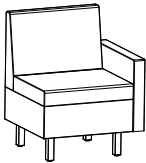

Parent #	Description	Model #	List Price
MRJLGLU	<b>Murj Lounge Chair, Left Arm</b>  Seat: 24"W x 19"D x 18.5"H Back: 24"W x 15.25"H Arm: 6"H Overall: 27"W x 24"D x 33.75"H	MRJLGLU	1,658.00

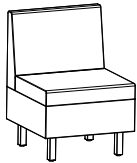

Parent #	Description	Model #	List Price
MRJLGAU	<b>Murj Lounge Chair, Armless</b>  Seat: 24"W x 19"D x 18.5"H Back: 24"W x 15.25"H Overall: 24"W x 24"D x 33.75"H	MRJLGAU	1,524.00

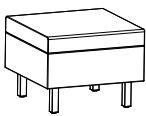

Parent #	Description	Model #	List Price
MRJLGOU	<b>Murj Lounge Ottoman</b>  Overall: 24"W x 24"D x 18.5"	MRJLGOU	1,255.00

### SEATING

Parent	Fabric
MRJLGBU - Lounge Chair Both Arms MRJLGLU - Lounge Chair Left Arm MRJLGRU - Lounge Chair Right Arm MRJLGAU - Lounge Chair Armless MRJLGOU - Lounge Ottoman	DT08 - Taupe DT15 - Platinum DT16 - Slate
<b>Example:</b> M R J L G B U +	D T 0 8
<b>Model Number</b>	<b>Configured Options</b>

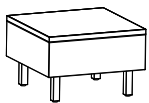

Parent #	Description	Model #	List Price
MRJLGTU	<b>Murj Lounge Table</b>  Overall: 24"W x 24"D x 18.5"	MRJLGTU	1,255.00

### TABLE

Parent	Fabric	Laminate Top
MRJLGTU - Lounge Table	DT08 - Taupe DT15 - Platinum DT16 - Slate	See above for HPL laminate with match 3mm edgeband choices
<b>Example:</b> M R J L G T U +	D T 0 8 +	A S N T
<b>Model Number</b>	<b>Configured Options</b>	

Laminate + Matching Edge Color Option

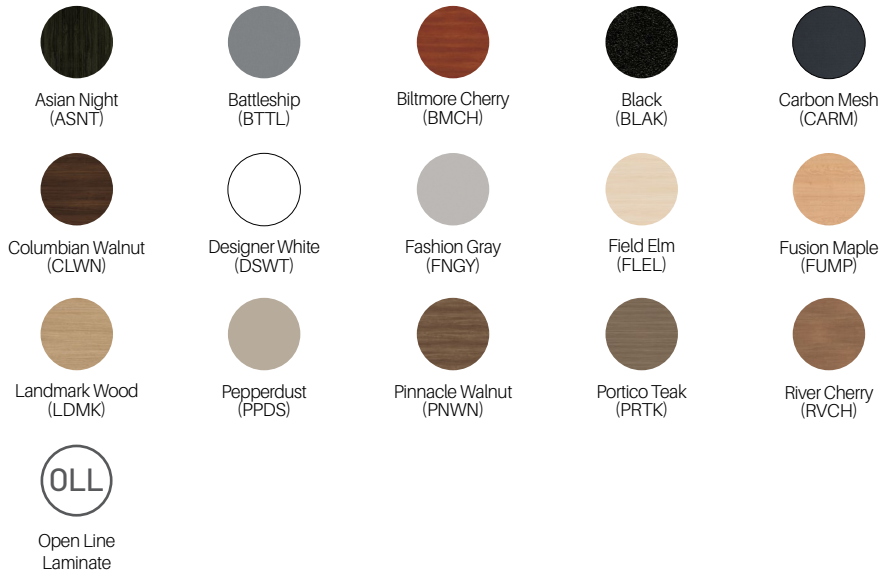

Base Color Options



Cutout Options

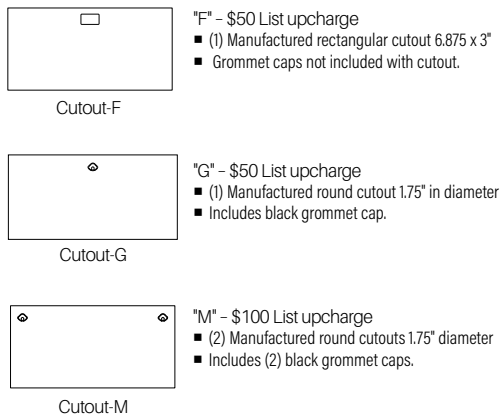

Laminate Edge Type

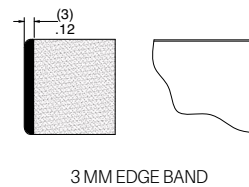

**Note:** All non-standard cutouts (other than above) will be reviewed to determine if the cutout does not interfere with the base, degrade table strength or cause imbalance. Contact [specials@onsemblesolutions.com](mailto:specials@onsemblesolutions.com) for quote request and drawing sign-off will be required before order is processed.

- A cohesive collection allowing specifiers to achieve a similar look throughout a space
- 1.125" thick tops with matching 3mm edge banding
- Tables available in Flip, T-Leg, Post-Leg, Café, Bistro, and Conference
- Flip tables feature dual-sided levers for a quick flip of the top
- Flip tables nest for compact storage
- Sitting-height tables are 29"H
- Bistro café tables are 42"H
- Textured SILVER powder coat bases
- Glide option includes 4 adjustable glides
- Caster options include 4 locking casters
- Manufactured cutouts and power option available

Akord Multi-Purpose Tables

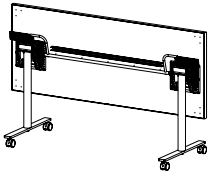
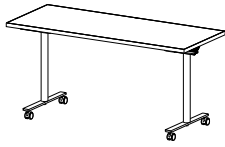

Akord Flip Base Table w/Casters

Model	Description	List Price
AKDFLP4818REC	Akord 48" x 18" Flip Base	1,790.00
AKDFLP4824REC	Akord 48" x 24" Flip Base	1,835.00
AKDFLP4830REC	Akord 48" x 30" Flip Base	1,949.00
AKDFLP5418REC	Akord 54" x 18" Flip Base	1,819.00
AKDFLP5424REC	Akord 54" x 24" Flip Base	1,871.00
AKDFLP5430REC	Akord 54" x 30" Flip Base	2,004.00
AKDFLP6018REC	Akord 60" x 18" Flip Base	1,931.00
AKDFLP6024REC	Akord 60" x 24" Flip Base	1,984.00
AKDFLP6030REC	Akord 60" x 30" Flip Base	2,143.00

Model	Description	List Price
AKDFLP6618REC	Akord 66" x 18" Flip Base	1,989.00
AKDFLP6624REC	Akord 66" x 24" Flip Base	2,041.00
AKDFLP6630REC	Akord 66" x 30" Flip Base	2,164.00
AKDFLP7218REC	Akord 72" x 18" Flip Base	2,062.00
AKDFLP7224REC	Akord 72" x 24" Flip Base	2,126.00
AKDFLP7230REC	Akord 72" x 30" Flip Base	2,280.00



Parent	Top Width	Top Depth	Top Shape	Leg Color	Power Cut Out	Top Color/Pattern
AKDFLP	48 54 60 66 72	18 24 30	REC - Rectangle	See page 19 for Base Color options	N - None F - Rectangle Cutout G - Center Rnd Cutout M - Left/Right Rnd Cutout	See page 19 for HPL laminate with matching 3mm edgeband choices
Example: <b>AKDFLP+</b>	<b>60+</b>	<b>24+</b>	<b>REC+</b>	<b>GRAY+</b>	<b>F+</b>	<b>ASNT</b>
<b>Model Number</b>				<b>Configured Options</b>		

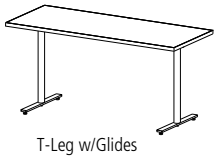

T-Leg w/Glides

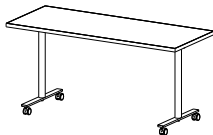

T-Leg w/Casters

Akord T-Leg Table

Model	Description	List Price
AKDFXT4818REC	Akord 48" x 18" T-Leg	1,377.00
AKDFXT4824REC	Akord 48" x 24" T-Leg	1,422.00
AKDFXT4830REC	Akord 48" x 30" T-Leg	1,536.00
AKDFXT5418REC	Akord 54" x 18" T-Leg	1,406.00
AKDFXT5424REC	Akord 54" x 24" T-Leg	1,456.00
AKDFXT5430REC	Akord 54" x 30" T-Leg	1,589.00
AKDFXT6018REC	Akord 60" x 18" T-Leg	1,505.00
AKDFXT6024REC	Akord 60" x 24" T-Leg	1,556.00
AKDFXT6030REC	Akord 60" x 30" T-Leg	1,715.00

Model	Description	List Price
AKDFXT6618REC	Akord 66" x 18" T-Leg	1,561.00
AKDFXT6624REC	Akord 66" x 24" T-Leg	1,613.00
AKDFXT6630REC	Akord 66" x 30" T-Leg	1,736.00
AKDFXT7218REC	Akord 72" x 18" T-Leg	1,589.00
AKDFXT7224REC	Akord 72" x 24" T-Leg	1,654.00
AKDFXT7230REC	Akord 72" x 30" T-Leg	1,808.00



Parent	Top Width	Top Depth	Top Shape	Casters/Glides	Leg Color	Power Cut Out	Top Color/Pattern
AKDFXT	48 54 60 66 72	18 24 30	REC - Rectangle	CA - Casters GL - Glides	See page 19 for Base Color options	N - None F - Rectangle Cutout G - Center Rnd Cutout M - Left/Right Rnd Cutout	See page 19 for HPL laminate with matching 3mm edgeband choices
Example: <b>AKDFXT+</b>	<b>60+</b>	<b>24+</b>	<b>REC+</b>	<b>CA+</b>	<b>GRAY+</b>	<b>F+</b>	<b>ASNT</b>
<b>Model Number</b>				<b>Configured Options</b>			

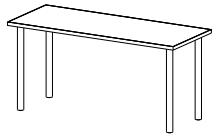

Post-Leg w/Glides

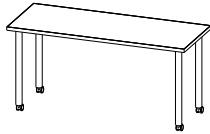

Post-Leg w/Casters

Akord Post-Leg Table

Model	Description	List Price
AKDFXP4818REC	Akord 48" x 18" Post Leg	1,228.00
AKDFXP4824REC	Akord 48" x 24" Post Leg	1,273.00
AKDFXP4830REC	Akord 48" x 30" Post Leg	1,387.00
AKDFXP5418REC	Akord 54" x 18" Post Leg	1,257.00
AKDFXP5424REC	Akord 54" x 24" Post Leg	1,307.00
AKDFXP5430REC	Akord 54" x 30" Post Leg	1,440.00
AKDFXP6018REC	Akord 60" x 18" Post Leg	1,354.00
AKDFXP6024REC	Akord 60" x 24" Post Leg	1,407.00
AKDFXP6030REC	Akord 60" x 30" Post Leg	1,651.00

Model	Description	List Price
AKDFXP6618REC	Akord 66" x 18" Post Leg	1,412.00
AKDFXP6624REC	Akord 66" x 24" Post Leg	1,464.00
AKDFXP6630REC	Akord 66" x 30" Post Leg	1,587.00
AKDFXP7218REC	Akord 72" x 18" Post Leg	1,440.00
AKDFXP7224REC	Akord 72" x 24" Post Leg	1,508.00
AKDFXP7230REC	Akord 72" x 30" Post Leg	1,660.00



Parent	Top Width	Top Depth	Top Shape	Casters/Glides	Leg Color	Power Cut Out	Top Color/Pattern
AKDFXP	48 54 60 66 72	18 24 30	REC - Rectangle	CA - Casters GL - Glides	See page 19 for Base Color options	N - None F - Rectangle Cutout G - Center Rnd Cutout M - Left/Right Rnd Cutout	See page 19 for HPL laminates with matching 3mm edgeband choices
Example: <b>AKDFXP+</b>	<b>60+</b>	<b>24+</b>	<b>REC+</b>	<b>CA+</b>	<b>GRAY+</b>	<b>F+</b>	<b>ASNT</b>
<b>Model Number</b>				<b>Configured Options</b>			

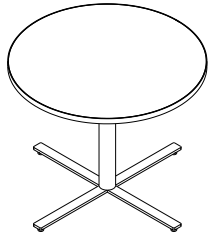

### Akord X-Base Table

Model	Description	List Price
AKDXBB36RND	Akord 36" Round Top, X-Base 42"H	1,545.00
AKDXBB36SQR	Akord 36" Square Top, X-Base 42"H	1,545.00
AKDXBB42RND	Akord 42" Round Top, X-Base 42"H	1,693.00
AKDXBB42SQR	Akord 42" Square Top, X-Base 42"H	1,693.00
AKDXBS36RND	Akord 36" Round Top, X-Base 29"H	1,474.00
AKDXBS36SQR	Akord 36" Square Top, X-Base 29"H	1,474.00
AKDXBS42RND	Akord 42" Round Top, X-Base 29"H	1,623.00
AKDXBS42SQR	Akord 42" Square Top, X-Base 29"H	1,623.00



Parent	Top Size	Top Shape	Leg Color	Top Color/Pattern
AKDXBS - Sitting Height AKDXBB - Bar Height	36 42	RND - Round SQR - Square	See page 19 for Base Color options	See page 19 for HPL laminates with matching 3mm edgeband choices
<b>Example:</b> <b>AKDXBS +</b>	<b>3 6 +</b>	<b>RND +</b>	<b>GRAY +</b>	<b>ASNT</b>
<b>Model Number</b>			<b>Configured Options</b>	

### Akord Disc-Base Table

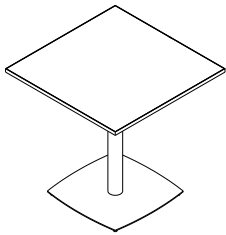

Model	Description	List Price
AKDDBB36RND	Akord 36" Round Top, Disc-Base 42"H	1,545.00
AKDDBB36SQR	Akord 36" Square Top, Disc-Base 42"H	1,545.00
AKDDBB42RND	Akord 42" Round Top, Disc-Base 42"H	1,693.00
AKDDBB42SQR	Akord 42" Square Top, Disc-Base 42"H	1,693.00
AKDDBS36RND	Akord 36" Round Top, Disc-Base 29"H	1,474.00
AKDDBS36SQR	Akord 36" Square Top, Disc-Base 29"H	1,474.00
AKDDBS42RND	Akord 42" Round Top, Disc-Base 29"H	1,623.00
AKDDBS42SQR	Akord 42" Square Top, Disc-Base 29"H	1,623.00



Parent	Top Size	Top Shape	Leg Color	Top Color/Pattern
AKDDBS - Sitting Height AKDDBB - Bar Height	36 42	RND - Round SQR - Square	See page 19 for Base Color options	See page 19 for HPL laminates with matching 3mm edgeband choices
<b>Example:</b> <b>AKDDBS +</b>	<b>3 6 +</b>	<b>RND +</b>	<b>GRAY +</b>	<b>ASNT</b>
<b>Model Number</b>			<b>Configured Options</b>	

### Akord Conference Table

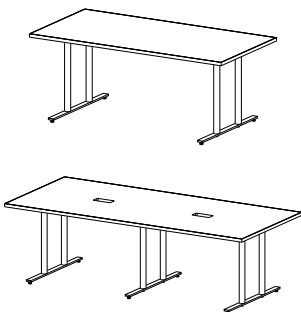

Model	Description	List Price
AKDCNF7236REC	Akord 72" x 36" Conference 29"H	2,220.00
AKDCNF8442REC	Akord 84" x 42" Conference 29"H	2,551.00
AKDCNF9642REC	Akord 96" x 42" Conference 29"H	3,401.00



Parent	Top Size	Top Shape	Leg Color	Power Cut Out	Top Color/Pattern
AKDCNF	7236 8442 9642	REC - Rectangle	See page 19 for Base Color options	N - None F - Rectangle Cutout	See page 19 for HPL laminates with matching 3mm edgeband choices
<b>Example:</b> <b>AKDCNF +</b>	<b>7 2 3 6 +</b>	<b>REC +</b>	<b>GRAY +</b>	<b>F +</b>	<b>ASNT</b>
<b>Model Number</b>			<b>Configured Options</b>		



PWR110V



PWRUSBAC

Model	Description	Color	List Price
PWR110VBL	Single Power Outlet	Black	185.00
PWR110VWH	Single Power Outlet	White	185.00
PWRUSBACBL	(1) USB-A/(1) USB-C Port	Black	576.00
PWRUSBACWH	(1) USB-A/(1) USB-C Port	White	576.00

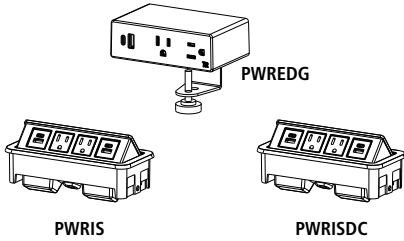

PWRIS

PWRISDC

PWREDGBL	<b>NEW</b> (2) 110V, (1) USB-A, (1) USB-C, Clamp Mount	Black	720.00
PWREDGWH	<b>NEW</b> (2) 110V, (1) USB-A, (1) USB-C, Clamp Mount	White	720.00
PWRISBL	<b>NEW</b> (2) 110V, (2) USB-A, (2) USB-C, Wall plug-In	Black	1,142.00
PWRISWH	<b>NEW</b> (2) 110V, (2) USB-A, (2) USB-C, Wall Plug-In	White	1,142.00
PWRISDCBL	<b>NEW</b> (2) 110V, (2) USB-A, (2) USB-C, Daisy Chain, 60"	Black	1,166.00
PWRISDCWH	<b>NEW</b> (2) 110V, (2) USB-A, (2) USB-C, Daisy Chain, 60"	White	1,166.00

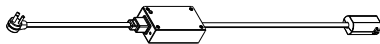

PWRDCSL	<b>NEW</b> Daisy Chain Starter Link (Required to start chain)		1,258.00
---------	---	--	----------

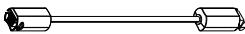

PWREXT	<b>NEW</b> Daisy Chain Extension, 12"		176.00
--------	---------------------------------------	--	--------

**For tables greater than 60" in length:**

Connect up to 8 Daisy Chain Power/Data Modules (PWRISDC) plus 12" Extension(s) (PWREXT) to each Daisy Chain Power Infeed (PWRDCSL)

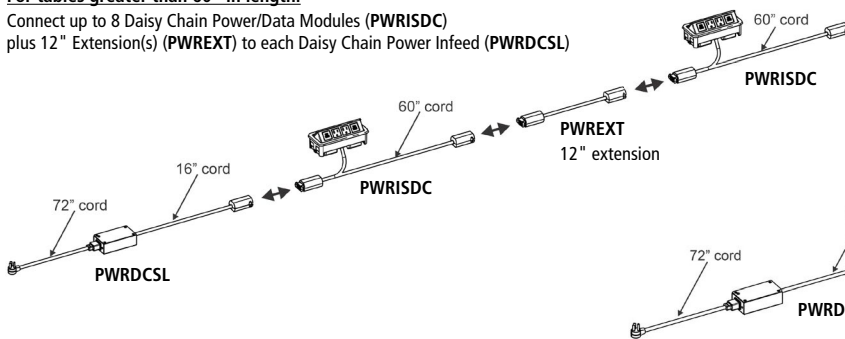

**For tables 60" or shorter in length:**

Connect up to 8 Daisy Chain Power/Data Modules (PWRISDC) to each Daisy Chain Power Infeed (PWRDCSL)

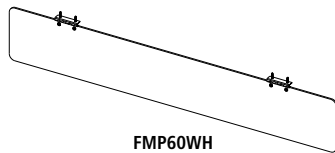
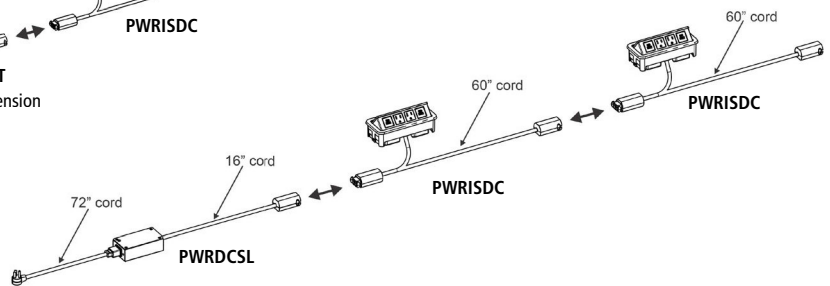

FMP60WH

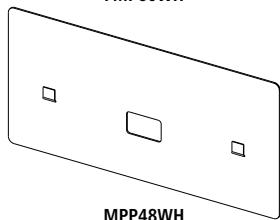

MPP48WH

Model	Description	Size	List Price
FMP48WH <b>PROP 65</b>	Flip Modesty Panel for 48" and 54" Tables	47.5"W x 11.5"H	514.00
FMP60WH <b>PROP 65</b>	Flip Modesty Panel for 60" and 66" Tables	59.5"W x 11.5"H	561.00
FMP72WH <b>PROP 65</b>	Flip Modesty Panel for 72" Table	71.5"W x 11.5"H	610.00
MPP48WH <b>PROP 65</b>	Privacy Modesty Panel 48" and 54" Tables	47.5"W x 23.5"H	457.00
MPP60WH <b>PROP 65</b>	Privacy Modesty Panel for 60" and 66" Tables	59.5"W x 23.5"H	562.00
MPP72WH <b>PROP 65</b>	Privacy Modesty Panel for 72" Table	71.5"W x 23.5"H	672.00



AKDWMCSL

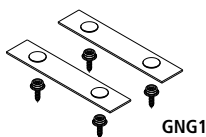

GNG1

Model	Description	Size	List Price
AKDWMCSL <b>NEW</b>	Akord Wire Management Cover, Silver Finish	2.25"W x 18"H x .25"D	125.00
GNG1 <b>NEW</b>	Akord Ganging Connectors, 5 sets	5"W x 7"D	233.00

# Jibe Table Collection

JIBE

## Laminate + Matching Edge Color Option

## Base Options

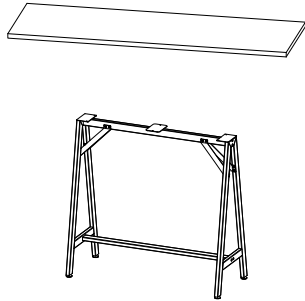

### Jibe Top SKU # Formula

Parent	Top Width	Top Depth	Top Shape	Base Color	Top Color/Pattern
<b>JBEAFB</b>	60 - 60" 72 - 72"	20 - 20" 24 - 24"	REC - Rectangle	BL - Black SL - Silver	See above for HPL laminate
Example: <b>J B E A F B +</b>	<b>6 0 +</b>	<b>2 0 +</b>	<b>R E C +</b>	<b>B L +</b>	<b>A S N T</b>
<b>Model Number</b>				<b>Configured Options</b>	

Ex: JBEAFB6020RECBLASNT – Jibe 60x20" Top in Asian Night with Black Base

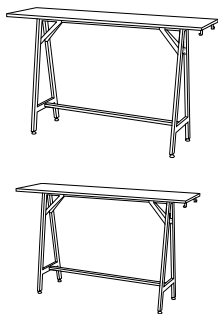

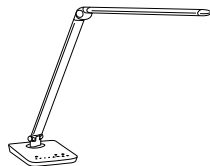

Model	Description	Size	List Price
JBEAFB6020REC	Jibe A-Frame Bar Height Table	60"W x 20"D x 42"H	1,303.00
JBEAFB6024REC	Jibe A-Frame Bar Height Table	60"W x 24"D x 42"H	1,446.00
JBEAFB7220REC	Jibe A-Frame Bar Height Table	72"W x 20"D x 42"H	1,551.00
JBEAFB7224REC	Jibe A-Frame Bar Height Table	72"W x 24"D x 42"H	1,727.00

LIGHTING

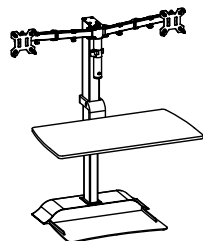

Parent #	Description	Color	Model #	List Price
LULDLP	Lulli LED Desk Lamp	Black	LULDLPBL	357.00
	5"W x 16"D x 16.75"H	Silver	LULDLP SL	
		White	LULDLPWH	



Parent #	Description	Color	Model #	List Price
ACCSSE	Accend Desktop Monitor Lift	White	ACCSSEWH	2,272.00
	Dual Monitor Arms			
	Overall: 27.75"W x 22"D x 18.5-37.25"H			

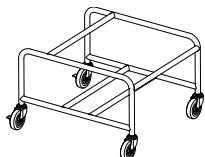

Parent #	Description	Model #	List Price
CRTSLD	Sled Base Stacking Chair Cart	CRTSLDSL	422.00
	Can stack 20 units depending on the chair		
	Overall: 23.5"W x 27.5"D x 17"H		

## Color Options



Granite  
(GRNT)



Graphite  
(GRPT)

- PET Material
- Handle Cutout 2" Radius
- Feet: 4" W x 2" H
- Available in Granite and Graphite

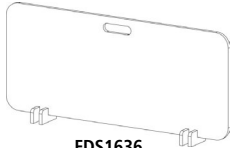

FDS1636



FDS1648



FDS1660

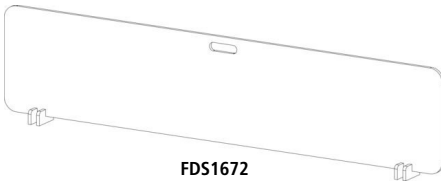

FDS1672

Model	Size	List Price
FDS1636	Screen Size: 36"W x 16"H	111.00
FDS1648	Screen Size: 48"W x 16"H	133.00
FDS1660	Screen Size: 60"W x 16"H	167.00
FDS1672	Screen Size: 72"W x 16"H	177.00

Parent	Color
FDS1636 - Desk Screen 36" FDS1648 - Desk Screen 48" FDS1660 - Desk Screen 60" FDS1672 - Desk Screen 72"	GRNT-Granite GRPT-Graphite
Example: F _ D _ S _ 1 _ 5 _ 3 _ 6 _ +	G _ R _ N _ T
<b>Model Number</b>	<b>Configured Options</b>

Introducing Cache, a personal storage solution for rapidly evolving environments. Cache is designed to seamlessly integrate within Onsemble applications and with other brands, while accommodating all the things you need to organize or store.

Laminate + Matching Edge Color Option



Powder Coat Paint Option

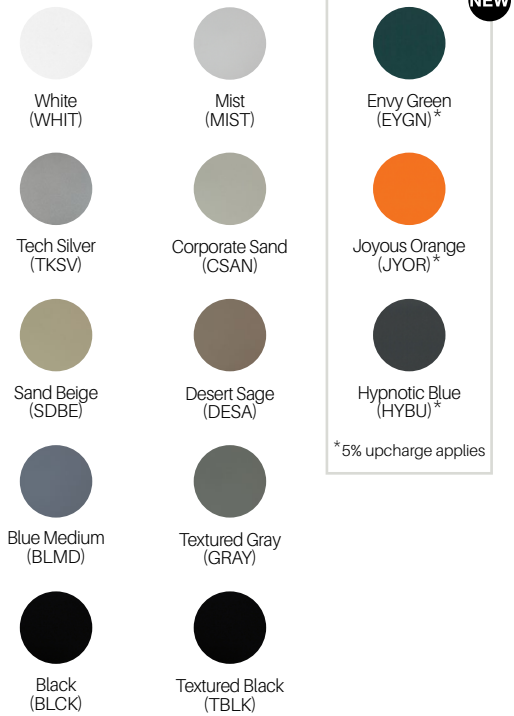

Paint Match Program

We offer pre-approved competitive paint options that are available with no additional upcharge. These options may impact lead times, pending availability of materials. Custom match paint colors are available upon request, contact Customer Service at [info@onsemblesolutions.com](mailto:info@onsemblesolutions.com).

Haworth



Herman Miller

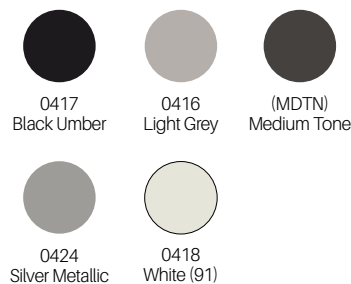

Knoll



Steelcase

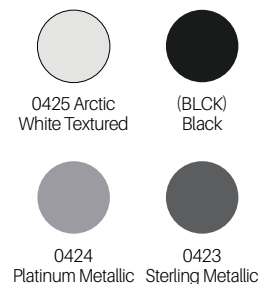

## DRAWER/DOOR FRONT FINISH OPTIONS

Choose between powder coat paints for the cabinet frame and laminates with matching edge band on the door and drawer fronts.

- Accommodates letter size hanging files
- Full extension ball bearing slides
- Keyed alike or random option
- All steel construction shells and components
- ANSI BIFMA X5.9 tested
- Limited lifetime warranty



Examples

## DRAWER/DOOR PULL OPTIONS

Arch Pull

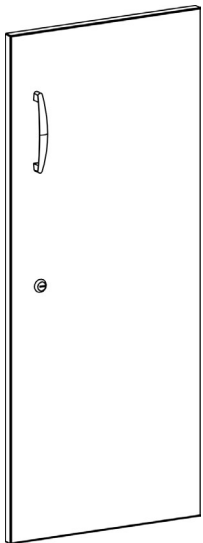
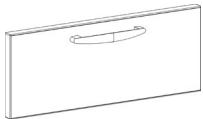

Bar Pull

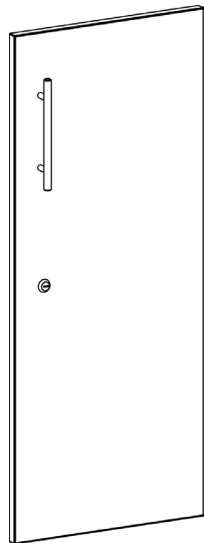
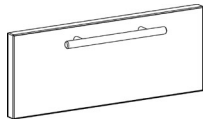

Loop Pull

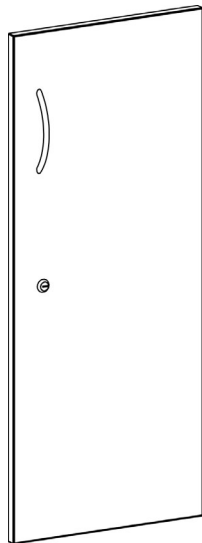
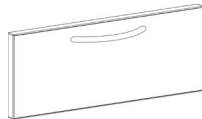

Wide Pull

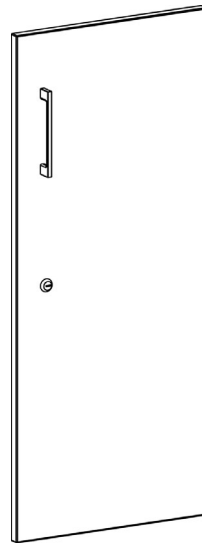
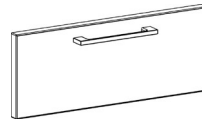

Leather Pull

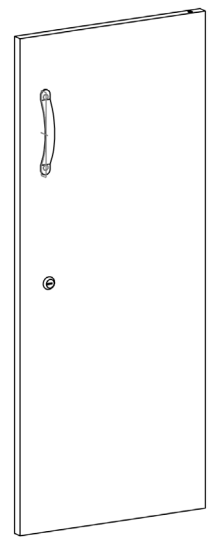
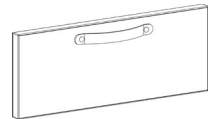

**Free Standing Pedestals** 

- Includes a drawer caster and 4 adjustable leveling glides for stability.

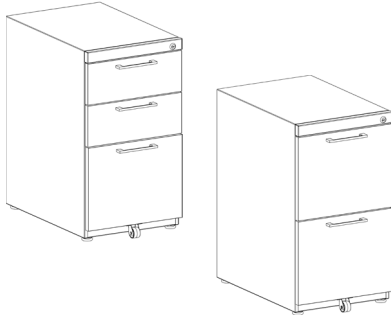

Model	Description	List Price
CACPEDFS22BBF	Box/Box/File, includes 3 pulls 15"W x 22.5"D x 27.3"H	1,528.00
CACPEDFS22FF	File/File, includes 2 pulls 15"W x 22.5"D x 27.3"H	1,415.00

**Mobile Pedestals** 

- Includes 4 hidden casters and one drawer caster.

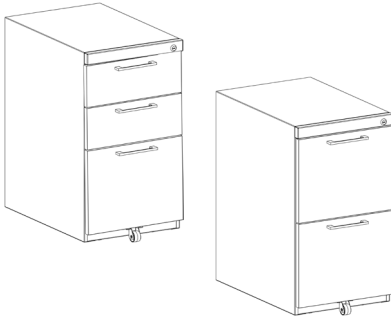

Model	Description	List Price
CACPEDMO22BBF	Box/Box/File, includes 3 pulls 15"W x 22.5"D x 27.3"H	1,568.00
CACPEDMO22FF	File/File, includes 2 pulls 15"W x 22.5"D x 27.3"H	1,449.00

**Support Pedestals** 

- Secure to a work surface using the pre-drilled holes provided.
- Includes 4 adjustable leveling glides.

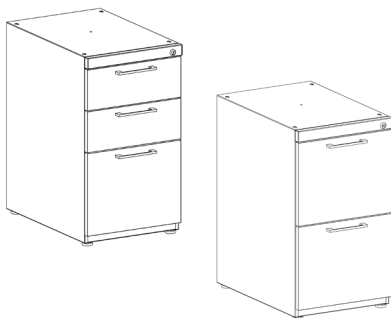

Model	Description	List Price
CACPEDSP22BBF	Box/Box/File, includes 3 pulls 15"W x 22.5"D x 27.3"H	1,479.00
CACPEDSP22FF	File/File, includes 2 pulls 15"W x 22.5"D x 27.3"H	1,364.00

Parent	Pedestal Type	Drawer Options	Cabinet Color	Drawer Material	Drawer Color	Lock Type	Pull Option
	FS22-Free Standing MO22-Mobile SP22-Support	BBF-Box/Box/File FF-File/File	See page 27 for powder coat paint choices	LAM-Laminate	See page 27 for laminates with matching edgeband choices	KA-Keyed Alike KD-Keyed Different	1B-Bar Pull Black 4B-Arch Pull Black 1S-Bar Pull Silver 4S-Arch Pull Silver 2B-Loop Pull Black 5B-Wide Pull Black 2S-Loop Pull Silver 5S-Wide Pull Silver 7N-Leather
Example: CACPED+	FS22+	FF+	BLCK+	LAM+	BLAK+	KA+	2B
<b>Model Number</b>			<b>Configured Options</b>				

## Bookcase Wardrobe Tower



Left Handed

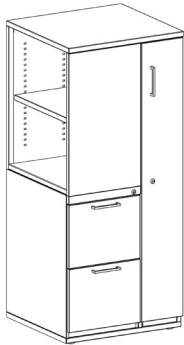

Left Handed

### Wardrobe Features

- Includes a standard dual coat hanger
- Adjustable door hinges
- Adjustable shelves
- Leveling Glides provide 1" of adjustment

Model	Description	List Price
CACWRDLO56BBF	Box/Box/File, Left Open, includes 4 pulls 24"W x 22.5"D x 56"H	6,004.00
CACWRDRO56BBF	Box/Box/File, Right Open, includes 4 pulls 24"W x 22.5"D x 56"H	6,004.00
CACWRDLO56FF	File/File, Left Open, includes 3 pulls 24"W x 22.5"D x 56"H	5,823.00
CACWRDRO56FF	File/File, Right Open, includes 3 pulls 24"W x 22.5"D x 56"H	5,823.00

## Cabinet Wardrobe Tower

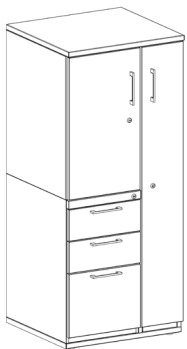

Left Handed

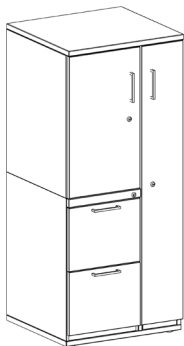

Left Handed

Model	Description	List Price
CACWRDLD56BBF	Box/Box/File, Left Door, includes 5 pulls 24"W x 22.5"D x 56"H	5,733.00
CACWRDRD56BBF	Box/Box/File, Right Door, includes 5 pulls 24"W x 22.5"D x 56"H	5,733.00
CACWRDLD56FF	File/File, Left Door, includes 4 pulls 24"W x 22.5"D x 56"H	5,374.00
CACWRDRD56FF	File/File, Right Door, includes 4 pulls 24"W x 22.5"D x 56"H	5,374.00

Parent	Wardrobe Type	Drawer Options	Cabinet Color	Drawer Material	Drawer Color	Lock Type	Pull Option
	<b>LO56</b> -Left Side Open <b>RO56</b> -Right Side Open <b>LD56</b> -Left Side Door <b>RD56</b> -Right Side Door	<b>BBF</b> -Box/Box/File <b>FF</b> -File/File	See page 27 for powder coat paint choices	<b>LAM</b> -Laminate	See page 27 for laminate with matching edgband choices	<b>KA</b> -Keyed Alike <b>KD</b> -Keyed Different	<b>1B</b> -Bar Pull Black <b>1S</b> -Bar Pull Silver <b>2B</b> -Loop Pull Black <b>2S</b> -Loop Pull Silver <b>7N</b> -Leather <b>4B</b> -Arch Pull Black <b>4S</b> -Arch Pull Silver <b>5B</b> -Wide Pull Black <b>5S</b> -Wide Pull Silver
Example: <b>CACWRD+</b>	<b>L O 5 6 +</b>	<b>F F +</b>	<b>B L C K +</b>	<b>L A M +</b>	<b>B L A K +</b>	<b>K A +</b>	<b>2 B</b>
<b>Model Number</b>			<b>Configured Options</b>				

Laminate + Matching Edge Color Option



Base Options

- 36" lockers available with two 18" doors with internal dividing shelf
- Keyed (random - master key available) or Digital Locks (revolving code)
- Individual locker modules ship fully assembled
- Concealed adjustable door hinges
- Work surfaces are constructed with 1.125" particle board with HPL and 3mm PVC edge banding
- 4 leveling glides for easy alignment (per locker)
- Ganging hardware included for front to back, side to side, and top to bottom connection
- Optional toe-kick for use with UNYLOCFS18 & UNYLOCFS36
- All steel is finished with powder coat paint (white or textured black)

Laminate Edge Type

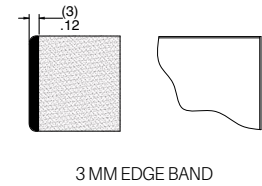

Fabric Options

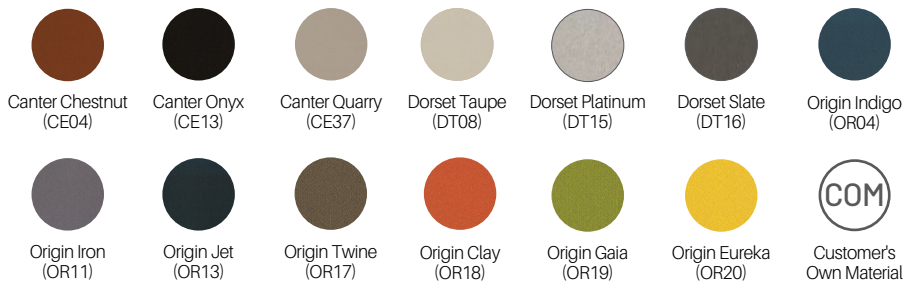

## FREE-STANDING LOCKERS

Parent #	Description	Model #	List Price
UNY01	Bench with Cushion	UNY01	4,885.00



Locker Height: 18.5"  
 Seat Size: 60"W x 18"D  
 Overall Size: 60"W x 18"D x 20.5"H

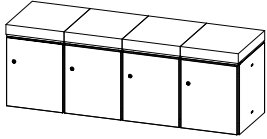

Option	Upcharge
Door Material Steel or Laminate (HPL)	N/C
Lock Type	N/C
Keyed Lock	N/C
Digital Lock - DL (Price is Per Lock)	204.00
Metal Color	N/C
White Powder Coat	N/C
Black Textured Powder Coat	N/C

Parent	Cabinet Color	Door Material	Door Color	Lock Type	Fabric
UNY01	WH - White BL - Black Textured	STE - Steel LAM - Laminate	See page 31 for laminate with matching edgeband choices	KL - Keyed Lock DL - Digital Lock	See page 31 for fabric options
Example: <b>UNY01 +</b> -----	<b>B L +</b> --	<b>L AM +</b> --	<b>C LWN +</b> -----	<b>D L +</b> --	<b>OR 11</b> -----
<b>Model Number</b>	<b>Configured Options</b>				

## STAND-ALONE LOCKER OPTIONS

Parent #	Description	Model #	List Price
UNYLOCFS18	18" Single Locker	UNYLOCFS18	932.00



Overall Size: 15"W x 18"D x 18.5"H

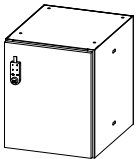

Parent #	Description	Model #	List Price
UNYLOCFS36	36" Single Locker	UNYLOCFS36	1,736.00



Overall Size: 15"W x 18"D x 36.5"H  
 Number of Doors for 36" Lockers: Double Door-DD

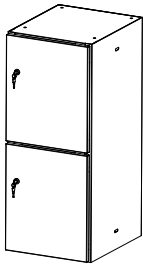

Option	Upcharge
Door Material Steel	N/C
Lock Type	N/C
Keyed Lock	N/C
Digital Lock - DL (Price is Per Lock)	204.00
Metal Color	N/C
White Powder Coat	N/C
Black Textured Powder Coat	N/C

Parent	Number of Doors*	Cabinet Color	Door Material	Door Color	Lock Type
UNYLOCFS18 UNYLOCFS36	DD-Double Door SD-Single Door	WH - White BL - Black Textured	STE - Steel LAM - Laminate	See page 31 for laminate with matching edgeband choices	KL - Keyed Lock DL - Digital Lock
Example: <b>UNYLOCFS36 +</b> -----	<b>DD +</b> --	<b>B L +</b> --	<b>L AM +</b> --	<b>DSWT +</b> -----	<b>K D</b> --
<b>Model Number</b>	<b>Configured Options</b>				

\*Single Door (SD) only available on UNYLOCFS36

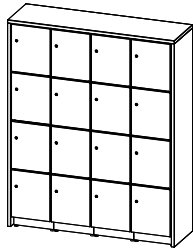

Parent #	Description	Model #	List Price
UNY06	Locker Wall	UNY06	16,607.00
	Overall Size: Overall Size: 62.5"W x 18.5"D x 77.5"H Number of Doors for 36" Lockers: Double Door-DD		
Option	Upcharge		
Door Material Steel	N/C		
Lock Type	N/C		
Keyed Lock	N/C		
Digital Lock - DL (Price is Per Lock)	204.00		
Metal Color	N/C		
White Powder Coat	N/C		
Black Textured Powder Coat	N/C		

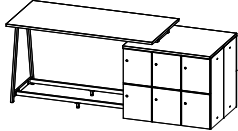

Parent #	Description	Model #	List Price
UNY08	A-Frame w/Riser (Long)	UNY08	16,138.00
	Counter Size: 75"W x 37"D Locker Surface Height: 37.75"H Overall Size: 105"W x 37"D x 41.5"H Number of Doors for 36" Lockers: Double Door-DD		

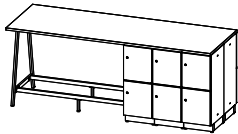

Parent #	Description	Model #	List Price
UNY10	A-Frame Bistro (Long)	UNY10	15,988.00
	Counter Size: 105"W x 37"D Overall Size: 105"W x 37"D x 41.5"H Number of Doors for 36" Lockers: Double Door-DD		

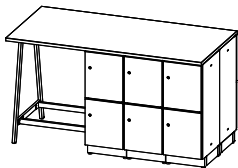

Parent #	Description	Model #	List Price
UNY11	A-Frame Bistro (Short)	UNY11	14,202.00
	Counter Size: 75"W x 37"D Overall Size: 75"W x 37"D x 41.5"H Number of Doors for 36" Lockers: Double Door-DD		

Option	Upcharge
Door Material Steel	N/C
Lock Type	N/C
Keyed Lock	N/C
Digital Lock - DL (Price is Per Lock)	204.00
Metal Color	N/C
White Powder Coat	N/C
Black Textured Powder Coat	N/C

Parent	Base Color	Worksurface and Waterfall Color (HPL)	Number of Doors	Door Material	Door Color (HPL only)	Lock Type	
UNY06 UNY08 UNY10 UNY11	WH - White BL - Black Textured	See page 31 for laminate with matching edgeband choices	DD - Double Door SD - Single Door	STE - Steel LAM - Laminate	See page 31 for laminate with matching edgeband choices *for Steel Door (STE), leave blank	KL - Keyed Lock DL - Digital Lock	
Example:	<u>U</u> <u>Y</u> <u>N</u> <u>0</u> <u>6</u> +	<u>B</u> <u>L</u> +	<u>O</u> <u>R</u> <u>1</u> <u>8</u> +	<u>D</u> <u>D</u> +	<u>L</u> <u>A</u> <u>M</u> +	<u>O</u> <u>R</u> <u>1</u> <u>8</u> +	<u>D</u> <u>L</u>
<b>Model Number</b>	<b>Configured Options</b>						

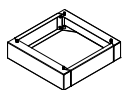

Parent #	Description	Color	Model #	List Price
UNYTKC	Toe-Kick Option for UNYLOCF518 & UNYLOCF536	Black Textured White	UNYTKCBL UNYTKCWH	140.00
	Overall Size: 15"W x 15"D x 3.625"H			



Description	Material	Model #	List Price
UNY-KEYS	Replacement Key 201-300*	201-300	44.00
Replacement Keys	920000462 Master Key	920000462	

\*When requesting a replacement key the lock/key number, located on the face of the lock, is required.

# Storage Collections

STORAGE COLLECTIONS

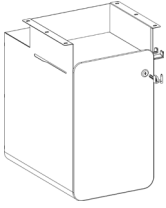

Parent #	Description	Color	Model #	List Price
VYBLOCSU	<b>Vybe Under Mount Desk Storage</b> 14.4"W x 15.9"D x 19.4"H	Granite grey felt door on white metal locker Graphite felt door on black metal locker	VYBLOCSUGRNTWH VYBLOCSUGRPTBL	504.00

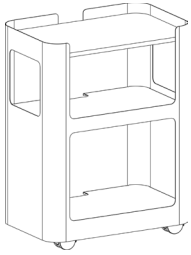

Parent #	Description	Color	Model #	List Price
MOBCART	<b>Mobe Open Shelf Mobile Cabinet</b> 18.1"W x 11.4"D x 23.9"H	White with Walnut top	MOBCARTWLWH	489.00

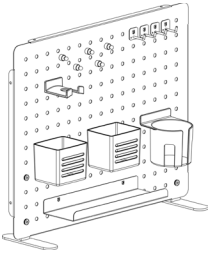

Parent #	Description	Color	Model #	List Price
FRSVERTPB	<b>Desktop Pegboard</b> 20.5"W x 6.2"D x 16.9"H	White Black	FRSVERTPBWH FRSVERTPBBL	167.00

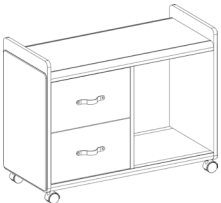

Parent #	Description	Color	Model #	List Price
ATDVDRMO	<b>Atytd Trolley Vertical Drawers</b> 35.4"W x 15.8"D x 27.6"H	White with White top	ATDVDRMOWHWH	1,738.00



Parent #	Description	Color	Model #	List Price
ATDHDRMO	<b>Atytd Trolley Horizontal Drawers</b> 35.4"W x 15.8"D x 27.6"H	White with White top	ATDHDRMOWHWH	1,738.00

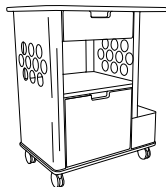

Parent #	Description	Color	Model #	List Price
SPHRSC	<b>Sphyr Rolling Storage Cart</b> Overall Size: 28"W x 20"D x 33.5"H Work Surface: 28"W x 20"D Slide-Out Drawer 1: 15.75"W x 15.75"D x 5"H Slide-Out Drawer 2: 15.75"W x 15.75"D x 13.375"H Side Compartment: 5.5"W x 17.5"D x 7"H	Silver Frame with White Top	SPHRSCWH	1,904.00



Parent #	Description	Color	Model #	List Price
STRHRD	Half Round Receptacle	White	STRHRDWH	836.00
	23 Gallon Capacity 10.25"W x 20.25"D x 32.25"H Includes: Can, Rim, Liner, and Sheet of 8 Black Decals (two of each option) <b>Decals Included: COMPOST, MIXED RECYCLING, TRASH, WASTE</b>	Silver	STRHRDSL	



Parent #	Description	Color	Model #	List Price
STRREC	Rectangular Receptacle	White	STRRECWH	836.00
	29 Gallon Capacity 10.25"W x 20.25"D x 32.25"H Includes: Can, Rim, Liner, and Sheet of 8 Black Decals (two of each option) <b>Decals Included: COMPOST, MIXED RECYCLING, TRASH, WASTE</b>	Silver	STRRECSSL	

Introducing Modix, the innovative solution designed to revolutionize traditional panel and desking systems. Modix seamlessly bridges the gap between technical workstations and front office environments, offering a versatile platform that evolves to meet a variety of needs. Its flexible and adaptive design allows for the creation of customizable, attractive workstations that cater to diverse requirements. Featuring a range of relevant material options and practical features, Modix is the standout choice perfectly designed to meet the evolving needs of modern workspaces.

## Laminate + Matching Edge Color Option



## Powder Coat

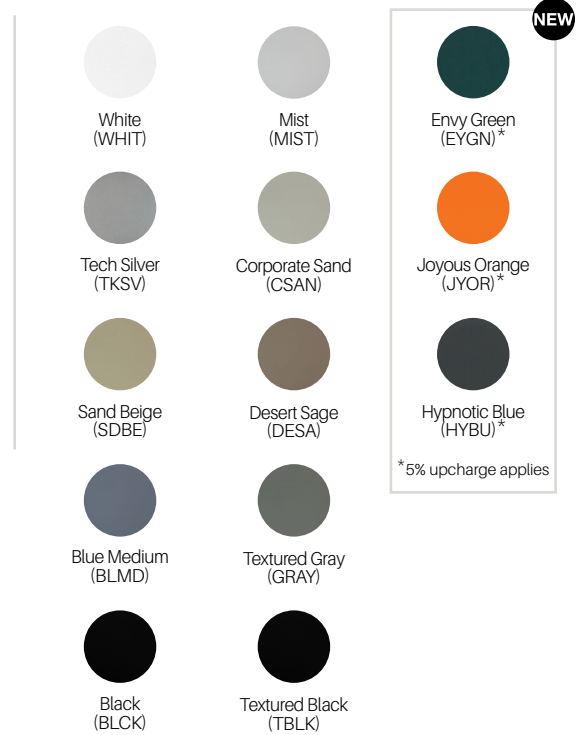

## Cutout Options

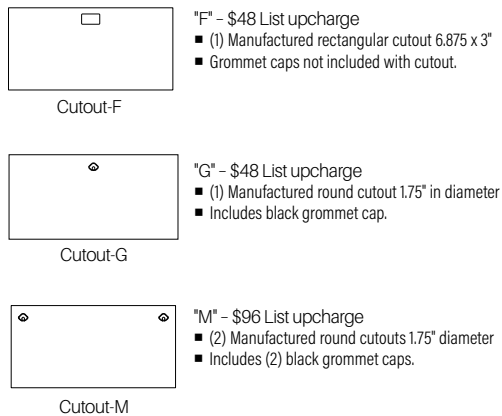

## Laminate Edge Type

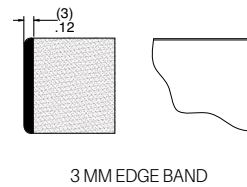

**Note:** All non-standard cutouts (other than above) will be reviewed to determine if the cutout does not interfere with the base, degrade table strength or cause imbalance. Contact [specials@onsemblesolutions.com](mailto:specials@onsemblesolutions.com) for quote request and drawing sign-off will be required before order is processed.

### Modix Desks Features

Desks have 14" of travel range measuring 26" to 40"H from floor to the top of the work surface. Adjusts in 1" increments with threaded fasteners. Desks come standard with black hardware and black leveling glides; Optional caster kits are available for an additional \$384 list, featuring a set of 4 casters (Item CASKIT4). Casters will add 4" to overall desk height. Desks ship knocked down.

- Standard work surface options include:  
HPL (High Pressure Laminate 1.125" thick) with 3mm edge band
- Grommet cutouts are available at an upcharge.
- Additional colors and work surface materials are available - upcharges, minimums and extended lead times may apply. Email [specials@onsemblesolutions.com](mailto:specials@onsemblesolutions.com) for quotation.
- Integrated cable management trough at the rear of each desk ensures that cords are neatly concealed and organized.
- The trough comes standard in a sleek black finish.

Parent	Type	Top Width	Top Depth	Top Shape	Glides/Casters	Base Color	Top Surface Material	Power Cut Out	Top Color/Pattern
MDX - Modix	DSK - Desk	36 42 48 54 60 66 72	24 30 36	REC - Rectangle	GL - Glides CA - Casters	See page 36	LAM - Laminate	N - None M - Left/Right Round Cutout	See page 36
<b>Example:</b> MDX +	DSK +	48 +	24 +	REC +	GL +	BLMD +	LAM +	M +	PPDS
<b>Model Number</b>					<b>Configured Options</b>				

### Surface Cutout Options (Desks Only)

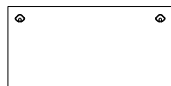

Cutout-M

- \*M\* - \$100 List upcharge
- (2) Manufactured round cutouts 1.75" diameter
- Includes (2) black grommet caps.

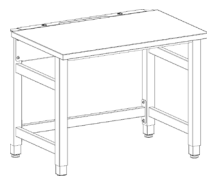

#### 36"W Rectangular Desk

Model	Description	List Price
MDXD3624REC	36"W x 24"D x 26-40"H Adjustable Height Desk	2,692.00
MDXD3630REC	36"W x 30"D x 26-40"H Adjustable Height Desk	2,877.00
MDXD3636REC	36"W x 36"D x 26-40"H Adjustable Height Desk	3,062.00

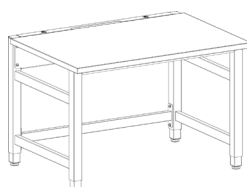

#### 42"W Rectangular Desk

Model	Description	List Price
MDXD4224REC	42"W x 24"D x 26-40"H Adjustable Height Desk	2,771.00
MDXD4230REC	42"W x 30"D x 26-40"H Adjustable Height Desk	2,956.00
MDXD4236REC	42"W x 36"D x 26-40"H Adjustable Height Desk	3,141.00





### 48"W Rectangular Desk

Model	Description	List Price
MDXDSK4824REC	48"W x 24"D x 26-40"H Adjustable Height Desk	2,851.00
MDXDSK4830REC	48"W x 30"D x 26-40"H Adjustable Height Desk	3,035.00
MDXDSK4836REC	48"W x 36"D x 26-40"H Adjustable Height Desk	3,220.00



### 54"W Rectangular Desk

Model	Description	List Price
MDXDSK5424REC	54"W x 24"D x 26-40"H Adjustable Height Desk	2,930.00
MDXDSK5430REC	54"W x 30"D x 26-40"H Adjustable Height Desk	3,114.00
MDXDSK5436REC	54"W x 36"D x 26-40"H Adjustable Height Desk	3,299.00



### 60"W Rectangular Desk

Model	Description	List Price
MDXDSK6024REC	60"W x 24"D x 26-40"H Adjustable Height Desk	3,009.00
MDXDSK6030REC	60"W x 30"D x 26-40"H Adjustable Height Desk	3,193.00
MDXDSK6036REC	60"W x 36"D x 26-40"H Adjustable Height Desk	3,378.00



### 66"W Rectangular Desk

Model	Description	List Price
MDXDSK6624REC	66"W x 24"D x 26-40"H Adjustable Height Desk	3,088.00
MDXDSK6630REC	66"W x 30"D x 26-40"H Adjustable Height Desk	3,273.00
MDXDSK6636REC	66"W x 36"D x 26-40"H Adjustable Height Desk	3,457.00

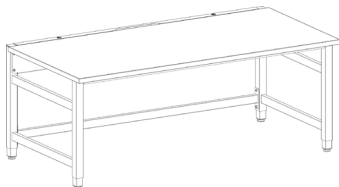

### 72"W Rectangular Desk

Model	Description	List Price
MDXDSK7224REC	72"W x 24"D x 26-40"H Adjustable Height Desk	3,167.00
MDXDSK7230REC	72"W x 30"D x 26-40"H Adjustable Height Desk	3,352.00
MDXDSK7236REC	72"W x 36"D x 26-40"H Adjustable Height Desk	3,536.00

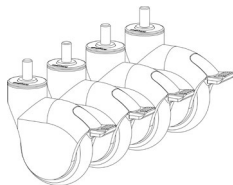

### Caster Kit

Model	Description	List Price
CASKIT4	Caster Kit - Set of 4	399.00

**Modix Return Features**

Returns have 14" of travel range measuring 26" to 40"H from floor to the top of the work surface. Adjusts in 1" increments with threaded fasteners. Returns come standard with black hardware and black leveling glides; no caster option available.

Non-handed.

Returns ship knocked down.

- Standard work surface options include:  
HPL (High Pressure Laminate 1.125" thick) with 3mm edge band.
- Additional colors and work surface materials are available - upcharges, minimums and extended lead times may apply. Email [specials@onsemblesolutions.com](mailto:specials@onsemblesolutions.com) for quotation.
- Returns feature a flexible design that allows for attachment to desks and tables at multiple increments, accommodating a wide range of space configurations and user needs.

Parent	Type	Top Width	Top Depth	Top Shape	Glides	Base Color	Top Surface Material	Power Cut Out	Top Color/Pattern
MDX - Modix	RTN - Return	36 42	18 24	REC - Rectangle	GL - Glides	See page 36	LAM - Laminate	N - None	See page 36
<b>Example:</b> M D X +	R T N +	3 6 +	2 4 +	R E C +	G L +	B L C K +	L A M +	N +	P N W N
<b>Model Number</b>					<b>Configured Options</b>				

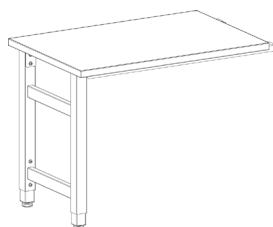

**36"W Rectangular Return**

Model	Description	List Price
MDXRTN3618REC	36"W x 18"D x 26-40"H Adjustable Height Return	1,346.00
MDXRTN3624REC	36"W x 24"D x 26-40"H Adjustable Height Return	1,531.00

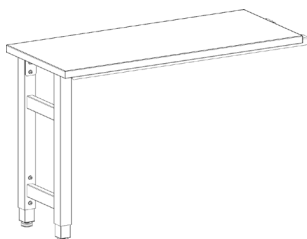

**42"W Rectangular Return**

Model	Description	List Price
MDXRTN4218REC	42"W x 18"D x 26-40"H Adjustable Height Return	1,425.00
MDXRTN4224REC	42"W x 24"D x 26-40"H Adjustable Height Return	1,610.00



## Modix Table Features

Tables have 14" of travel range measuring 26" to 40"H from floor to the top of the work surface. Adjusts in 1" increments with threaded fasteners. Tables come standard with black hardware and black leveling glides; Optional caster kits are available for an additional \$384 list, featuring a set of 4 casters (Item CASKIT4). Casters will add 4" to overall table height. Tables ship knocked down.

- Standard work surface options include:
  - HPL (High Pressure Laminate 1.125" thick) with 3mm edge band.
- Grommet and electrical cutouts are available at an upcharge.
- Additional colors and work surface materials are available - upcharges, minimums and extended lead times may apply. Email [specials@onsemblesolutions.com](mailto:specials@onsemblesolutions.com) for quotation.
- Optional lower shelves are available on 36", 42", and 48"D tables.
- All tables come equipped with built-in footrests. A single footrest is standard on 24" and 30"D tables, while dual footrests are standard on 36", 42", and 48"D tables.

Parent	Type	Top Width	Top Depth	Top Shape	Glides/Casters	Base Color	Top Surface Material	Power Cut Out	Top Color/Pattern
MDX - Modix	TBL - Table	48 54 60 66 72 78 84	24 30 36 42 48	REC - Rectangle	GL - Glides CA - Casters	See page 36	LAM - Laminate	N - None F - Rectangle G - Center Round M - Left/Right Round	See page 36
<b>Example:</b>									
<u>M</u> <u>D</u> <u>X</u> +	<u>T</u> <u>B</u> <u>L</u> +	<u>8</u> <u>4</u> +	<u>4</u> <u>8</u> +	<u>R</u> <u>E</u> <u>C</u> +	<u>C</u> <u>A</u> +	<u>J</u> <u>Y</u> <u>O</u> <u>R</u> +	<u>L</u> <u>A</u> <u>M</u> +	<u>F</u> +	<u>D</u> <u>S</u> <u>W</u> <u>T</u>
<b>Model Number</b>					<b>Configured Options</b>				

## Surface Cutout Options (Tables Only)

### 24" & 30" D Tables



Cutout-F

- "F" - \$50 List upcharge
- (1) Manufactured rectangular cutout 6.875 x 3"
  - Grommet caps not included with cutout



Cutout-G

- "G" - \$50 List upcharge
- (1) Manufactured round cutout 1.75" in diameter
  - Includes black grommet cap



Cutout-M

- "M" - \$100 List upcharge
- (2) Manufactured round cutouts 1.75" diameter
  - Includes (2) black grommet caps

### 36", 42" & 48" D Tables



Cutout-F

- "F" - \$50 List upcharge
- (1) Manufactured rectangular cutout 6.875 x 3"
  - Grommet caps not included with cutout



Cutout-G

- "G" - \$50 List upcharge
- (1) Manufactured round cutout 1.75" in diameter
  - Includes black grommet cap



Cutout-M

- "M" - \$100 List upcharge
- (2) Manufactured round cutouts 1.75" diameter
  - Includes (2) black grommet caps

### 48"W Rectangular Table

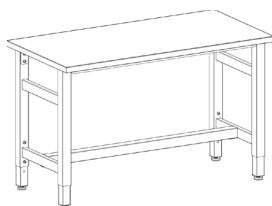

Model	Description	List Price
MDXTBL4824REC	48"W x 24"D x 26-40"H Adjustable Height Table	2,533.00
MDXTBL4830REC	48"W x 30"D x 26-40"H Adjustable Height Table	2,719.00
MDXTBL4836REC	48"W x 36"D x 26-40"H Adjustable Height Table	2,903.00
MDXTBL4842REC	48"W x 42"D x 26-40"H Adjustable Height Table	3,088.00
MDXTBL4848REC	48"W x 48"D x 26-40"H Adjustable Height Table	3,273.00



### 54"W Rectangular Table

Model	Description	List Price
MDXTBL5424REC	54"W x 24"D x 26-40"H Adjustable Height Table	2,612.00
MDXTBL5430REC	54"W x 30"D x 26-40"H Adjustable Height Table	2,798.00
MDXTBL5436REC	54"W x 36"D x 26-40"H Adjustable Height Table	2,982.00
MDXTBL5442REC	54"W x 42"D x 26-40"H Adjustable Height Table	3,167.00
MDXTBL5448REC	54"W x 48"D x 26-40"H Adjustable Height Table	3,352.00



60"W Rectangular Table

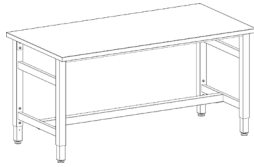

Model	Description	List Price
MDXTBL6024REC	60"W x 24"D x 26-40"H Adjustable Height Table	2,692.00
MDXTBL6030REC	60"W x 30"D x 26-40"H Adjustable Height Table	2,877.00
MDXTBL6036REC	60"W x 36"D x 26-40"H Adjustable Height Table	3,062.00
MDXTBL6042REC	60"W x 42"D x 26-40"H Adjustable Height Table	3,246.00
MDXTBL6048REC	60"W x 48"D x 26-40"H Adjustable Height Table	3,431.00



66"W Rectangular Table

Model	Description	List Price
MDXTBL6624REC	66"W x 24"D x 26-40"H Adjustable Height Table	2,771.00
MDXTBL6630REC	66"W x 30"D x 26-40"H Adjustable Height Table	2,956.00
MDXTBL6636REC	66"W x 36"D x 26-40"H Adjustable Height Table	3,141.00
MDXTBL6642REC	66"W x 42"D x 26-40"H Adjustable Height Table	3,325.00
MDXTBL6648REC	66"W x 48"D x 26-40"H Adjustable Height Table	3,510.00



72"W Rectangular Table

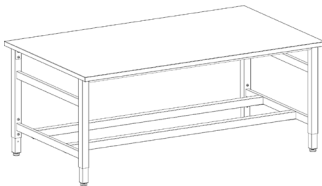

Model	Description	List Price
MDXTBL7224REC	72"W x 24"D x 26-40"H Adjustable Height Table	2,851.00
MDXTBL7230REC	72"W x 30"D x 26-40"H Adjustable Height Table	3,035.00
MDXTBL7236REC	72"W x 36"D x 26-40"H Adjustable Height Table	3,220.00
MDXTBL7242REC	72"W x 42"D x 26-40"H Adjustable Height Table	3,404.00
MDXTBL7248REC	72"W x 48"D x 26-40"H Adjustable Height Table	3,589.00



78"W Rectangular Table

Model	Description	List Price
MDXTBL7824REC	78"W x 24"D x 26-40"H Adjustable Height Table	2,966.00
MDXTBL7830REC	78"W x 30"D x 26-40"H Adjustable Height Table	3,151.00
MDXTBL7836REC	78"W x 36"D x 26-40"H Adjustable Height Table	3,335.00
MDXTBL7842REC	78"W x 42"D x 26-40"H Adjustable Height Table	3,520.00
MDXTBL7848REC	78"W x 48"D x 26-40"H Adjustable Height Table	3,706.00



84"W Rectangular Table

Model	Description	List Price
MDXTBL8424REC	84"W x 24"D x 26-40"H Adjustable Height Table	3,045.00
MDXTBL8430REC	84"W x 30"D x 26-40"H Adjustable Height Table	3,230.00
MDXTBL8436REC	84"W x 36"D x 26-40"H Adjustable Height Table	3,415.00
MDXTBL8442REC	84"W x 42"D x 26-40"H Adjustable Height Table	3,599.00
MDXTBL8448REC	84"W x 48"D x 26-40"H Adjustable Height Table	3,785.00

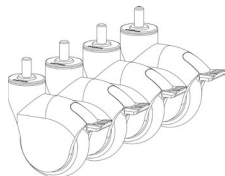

Caster Kit

Model	Description	List Price
CASKIT4	Caster Kit - Set of 4	399.00

## Modix Table Shelf Feature

Flexible Shelf Options: A single shelf extends half the length of the table and can easily slide along the footbars, allowing for customizable placement. For those seeking full coverage, two shelves are available, providing versatile solutions tailored to your needs. Simply order two shelves for complete coverage.

- Powder coated steel lower shelves fit on 36", 42" and 48"D tables only.
- Shelves are non-handed.

Parent	Type	Width	Depth	Shape	Color
MDX - Modix	TSH - Table Shelf	22 25 28 31 34 37 40	19	REC - Rectangle	See page 36
<b>Example:</b> M D X +	T S H +	3 7 +	1 9 +	R E C +	B L C K
<b>Model Number</b>					<b>Configured Options</b>

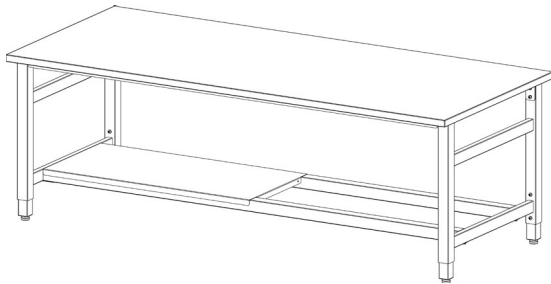

Half (1 Shelf)

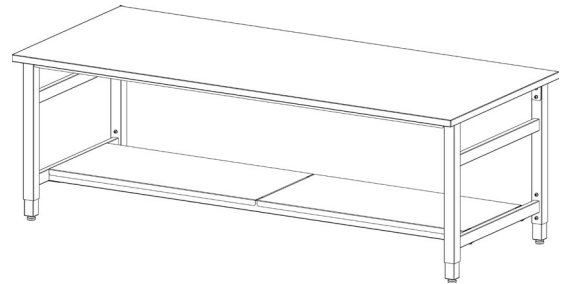

Full (2 Shelves)

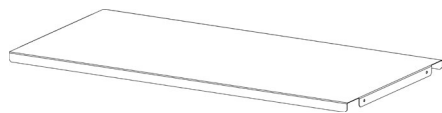

### Table Shelf

Model	Description	List Price
MDXTSH2219REC	22"W x 19"D Table Shelf (Fits 48"W x 36, 42, or 48"D Table)	385.00
MDXTSH2519REC	25"W x 19"D Table Shelf (Fits 54"W x 36, 42, or 48"D Table)	396.00
MDXTSH2819REC	28"W x 19"D Table Shelf (Fits 60"W x 36, 42, or 48"D Table)	407.00
MDXTSH3119REC	31"W x 19"D Table Shelf (Fits 66"W x 36, 42, or 48"D Table)	417.00
MDXTSH3419REC	34"W x 19"D Table Shelf (Fits 72"W x 36, 42, or 48"D Table)	427.00
MDXTSH3719REC	37"W x 19"D Table Shelf (Fits 78"W x 36, 42, or 48"D Table)	438.00
MDXTSH4019REC	40"W x 19"D Table Shelf (Fits 84"W x 36, 42, or 48"D Table)	448.00



## Modix Upper Frame Features

The upper frame design provides convenient support for hanging accessories above the work surface. Securely attached to the desk base, the fixed-height frame adjusts seamlessly with the desk, ensuring your essentials are always within reach.

- Each upper frame includes one stationary top bar and two configurable mounting bars, providing ample support for shelves, storage, and other accessories
- Upper frames are specifically designed to attach to Modix desks, with widths that correspond to the desk widths.
- Additional mounting bars can be purchased to expand your mounting options:  
 37"H upper frame can accommodate up to 2 additional bars (6 total including top bar)  
 25"H upper frame can accommodate up to 1 additional bar (4 total including top bar)
- The horizontal design allows users to easily relocate and slide accessories along the mounting bar, giving you the flexibility to customize your workstation to perfectly fit your needs.
- The upper frames are crafted from 14-gauge powder-coated steel, this construction ensures exceptional strength and durability.
- Mounting bars are crafted from durable 16-gauge powder-coated steel.

### Upper Frame

Parent	Type	Width	Height	Color Options
MDX - Modix	UFR - Upper Frame	36	25	See page 36
		42	37	
		48		
		54		
		60		
		66		
72				
Example: M D X +	U F R +	4 2 +	2 5 +	J Y O R
<b>Model Number</b>			<b>Configured Options</b>	

### Mounting Bar

Parent	Type	Width	Color Options
MDX - Modix	UMB - Upper Frame Mounting Bar	36	See page 36
		42	
		48	
		54	
		60	
		66	
72			
Example: M D X +	U M B +	4 8 +	J Y O R
<b>Model Number</b>		<b>Configured Options</b>	

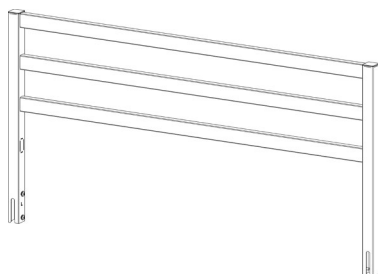

#### 25"H Upper Frame

Model	Description	List Price
MDXUFR3625	36"W x 25"H Upper Frame	1,169.00
MDXUFR4225	42"W x 25"H Upper Frame	1,328.00
MDXUFR4825	48"W x 25"H Upper Frame	1,486.00
MDXUFR5425	54"W x 25"H Upper Frame	1,562.00
MDXUFR6025	60"W x 25"H Upper Frame	1,638.00
MDXUFR6625	66"W x 25"H Upper Frame	1,722.00
MDXUFR7225	72"W x 25"H Upper Frame	1,810.00



#### 37"H Upper Frame

Model	Description	List Price
MDXUFR3637	36"W x 37"H Upper Frame	1,289.00
MDXUFR4237	42"W x 37"H Upper Frame	1,448.00
MDXUFR4837	48"W x 37"H Upper Frame	1,605.00
MDXUFR5437	54"W x 37"H Upper Frame	1,707.00
MDXUFR6037	60"W x 37"H Upper Frame	1,810.00
MDXUFR6637	66"W x 37"H Upper Frame	1,890.00
MDXUFR7237	72"W x 37"H Upper Frame	1,971.00



#### Additional Mounting Bars

Model	Description	List Price
MDXUMB36	36"W Upper Frame Mounting Bar	570.00
MDXUMB42	42"W Upper Frame Mounting Bar	607.00
MDXUMB48	48"W Upper Frame Mounting Bar	644.00
MDXUMB54	54"W Upper Frame Mounting Bar	681.00
MDXUMB60	60"W Upper Frame Mounting Bar	718.00
MDXUMB66	66"W Upper Frame Mounting Bar	755.00
MDXUMB72	72"W Upper Frame Mounting Bar	791.00



## Modix Upper Shelf Features

Upper shelves offer versatile storage solutions and are specifically designed to attach to the horizontal mounting bars of the upper frame structure. Depending on the shelf size, they can easily slide along the mounting bar or occupy the full length of the bar for maximum utilization.

- Available in durable high-pressure laminate (HPL) for added resilience.

Parent	Type	Width	Depth	Bracket Color	Shelf Material	Shelf Color/Pattern
MDX - Modix	USF - Upper Shelf	24 30 36 42 48 54 60 66 72	13 18	See page 36	LAM - Laminate	See page 36
Example: <u>M</u> <u>D</u> <u>X</u> +	<u>U</u> <u>S</u> <u>F</u> +	<u>4</u> <u>2</u> +	<u>1</u> <u>3</u> +	<u>S</u> <u>D</u> <u>B</u> <u>E</u> +	<u>L</u> <u>A</u> <u>M</u> +	<u>L</u> <u>D</u> <u>M</u> <u>K</u>
<b>Model Number</b>				<b>Configured Options</b>		

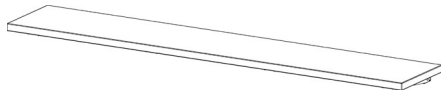

### 13"D Upper Shelves

Model	Description	List Price
MDXUSF2413	24"W x 13"D Upper Shelf	1,017.00
MDXUSF3013	30"W x 13"D Upper Shelf	1,054.00
MDXUSF3613	36"W x 13"D Upper Shelf	1,073.00
MDXUSF4213	42"W x 13"D Upper Shelf	1,101.00
MDXUSF4813	48"W x 13"D Upper Shelf	1,128.00
MDXUSF5413	54"W x 13"D Upper Shelf	1,195.00
MDXUSF6013	60"W x 13"D Upper Shelf	1,260.00
MDXUSF6613	66"W x 13"D Upper Shelf	1,323.00
MDXUSF7213	72"W x 13"D Upper Shelf	1,385.00



### 18"D Upper Shelves

Model	Description	List Price
MDXUSF2418	24"W x 18"D Upper Shelf	1,367.00
MDXUSF3018	30"W x 18"D Upper Shelf	1,411.00
MDXUSF3618	36"W x 18"D Upper Shelf	1,461.00
MDXUSF4218	42"W x 18"D Upper Shelf	1,483.00
MDXUSF4818	48"W x 18"D Upper Shelf	1,506.00
MDXUSF5418	54"W x 18"D Upper Shelf	1,591.00
MDXUSF6018	60"W x 18"D Upper Shelf	1,675.00
MDXUSF6618	66"W x 18"D Upper Shelf	1,761.00
MDXUSF7218	72"W x 18"D Upper Shelf	1,842.00

**Modix Overhead Cabinet Features**

Upper storage cabinets deliver flexible and efficient storage solutions, thoughtfully designed to securely attach to the horizontal mounting bars of the upper frame structure. Their innovative design allows for effortless sliding along the mounting bar, enabling seamless customization to suit individual preferences and optimize space.

- Available with robust laminate door fronts and a range of pull options to complement any aesthetic. Please refer to the chart below to select the preferred pull style.

Parent	Type 1	Type 2	Width	Depth	Height	Cabinet Paint Color	Door Material	Door Laminate Color	Lock Type	Pull Type
MDX - Modix	OHC - Overhead Cabinet	DD - Double Door	24 30 36	13	16	See page 36	LAM - Laminate	See page 36	KD - Keyed Different KA - Keyed Alike NL - No Lock	1B - Bar Black 1S - Bar Silver 2B - Loop Black 2S - Loop Silver 4B - Arch Black 4S - Arch Silver 5B - Wide Pull Black 5S - Wide Pull Silver
<b>Example:</b>	<u>M</u> <u>D</u> <u>X</u> +	<u>O</u> <u>H</u> <u>C</u> +	<u>2</u> <u>4</u> +	<u>1</u> <u>3</u> +	<u>1</u> <u>6</u> +	<u>B</u> <u>L</u> <u>C</u> <u>K</u> +	<u>L</u> <u>A</u> <u>M</u> +	<u>P</u> <u>N</u> <u>W</u> <u>N</u> +	<u>N</u> <u>L</u> +	<u>1</u> <u>B</u>
<b>Model Number</b>						<b>Configured Options</b>				

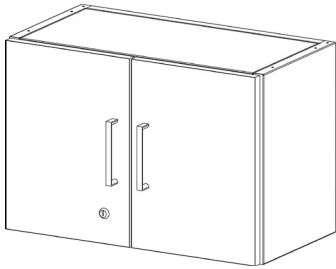

**Overhead Storage Cabinet**

Model	Description	List Price
MDXOHCDD241316	24"W x 13"D x 16"H Overhead Storage Cabinet	1,616.00
MDXOHCDD301316	30"W x 13"D x 16"H Overhead Storage Cabinet	1,726.00
MDXOHCDD361316	36"W x 13"D x 16"H Overhead Storage Cabinet	1,821.00



1B - Bar Black 1S - Bar Silver	2B - Loop Black 2S - Loop Silver	4B - Arch Black 4S - Arch Silver	5B - Wide Pull Black 5S - Wide Pull Silver



PWR110V



PWRUSBAC

Model	Description	Color	List Price
PWR110VBL	Single Power Outlet	Black	185.00
PWR110VWH	Single Power Outlet	White	185.00
PWRUSBACBL	(1) USB-A/(1) USB-C Port	Black	576.00
PWRUSBACWH	(1) USB-A/(1) USB-C Port	White	576.00
PWREDCBL	<b>NEW</b> (2) 110V, (1) USB-A, (1) USB-C, Clamp Mount	Black	720.00
PWREDCWH	<b>NEW</b> (2) 110V, (1) USB-A, (1) USB-C, Clamp Mount	White	720.00
PWRISBL	<b>NEW</b> (2) 110V, (2) USB-A, (2) USB-C, Wall plug-In	Black	1,142.00
PWRISWH	<b>NEW</b> (2) 110V, (2) USB-A, (2) USB-C, Wall Plug-In	White	1,142.00
PWRISDCBL	<b>NEW</b> (2) 110V, (2) USB-A, (2) USB-C, Daisy Chain, 60"	Black	1,166.00
PWRISDCWH	<b>NEW</b> (2) 110V, (2) USB-A, (2) USB-C, Daisy Chain, 60"	White	1,166.00
PWRDCSL	<b>NEW</b> Daisy Chain Starter Link (Required to start chain)		1,258.00
PWREXT	<b>NEW</b> Daisy Chain Extension, 12"		176.00

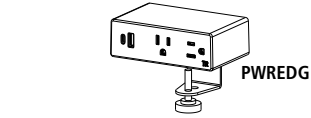

PWREDCG

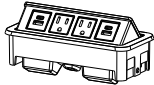

PWRIS

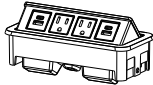

PWRISDC

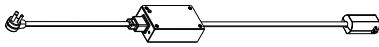

PWRDCSL

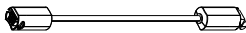

PWREXT

**For tables greater than 60" in length:**

Connect up to 8 Daisy Chain Power/Data Modules (PWRISDC) plus 12" Extension(s) (PWREXT) to each Daisy Chain Power Infeed (PWRDCSL)

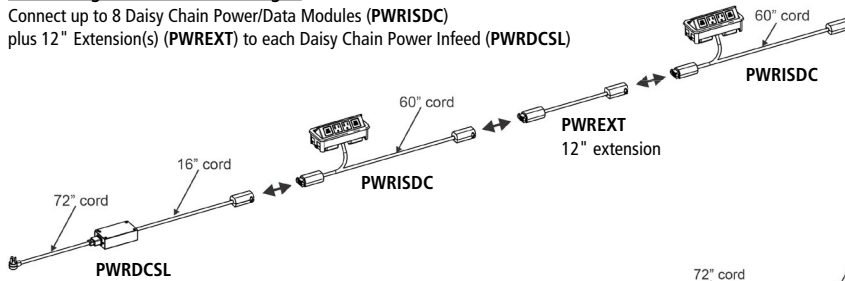

**For tables 60" or shorter in length:**

Connect up to 8 Daisy Chain Power/Data Modules (PWRISDC) to each Daisy Chain Power Infeed (PWRDCSL)

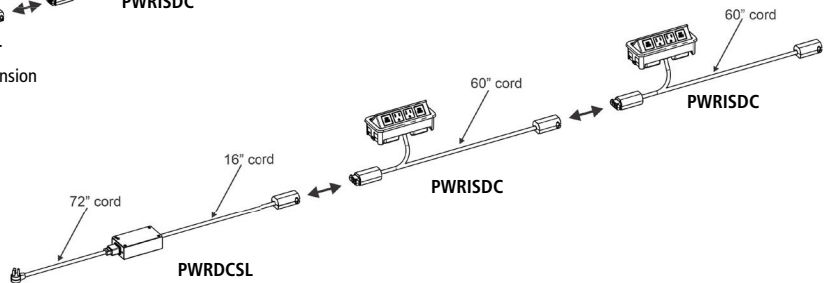

Model No.	Page	Model No.	Page	Model No.	Page	Model No.	Page
201-300	33	AKDFXT6630REC	20	MDXDSK6636REC	38	MDXUMB48	43
920000462	33	AKDFXT7218REC	20	MDXDSK7224REC	38	MDXUMB54	43
ACCSSEWH	25	AKDFXT7224REC	20	MDXDSK7230REC	38	MDXUMB60	43
ACZ4LGP	12	AKDFXT7230REC	20	MDXDSK7236REC	38	MDXUMB66	43
ACZ4LGU	12	AKDWMCSL	23	MDXOHCDD241316	45	MDXUMB72	43
ACZBSTP	14	AKDXBB36RND	22	MDXOHCDD301316	45	MDXUSF2413	44
ACZBSTU	14	AKDXBB36SQR	22	MDXOHCDD361316	45	MDXUSF2418	44
ACZECHP	14	AKDXBB42RND	22	MDXRTN3618REC	39	MDXUSF3013	44
ACZECHU	14	AKDXBB42SQR	22	MDXRTN3624REC	39	MDXUSF3018	44
ACZGCHP	13	AKDXBS36RND	22	MDXRTN4218REC	39	MDXUSF3613	44
ACZGCHU	13	AKDXBS36SQR	22	MDXRTN4224REC	39	MDXUSF3618	44
ACZSLDP	12	AKDXBS42RND	22	MDXTBL4824REC	40	MDXUSF4213	44
ACZSLDU	12	AKDXBS42SQR	22	MDXTBL4830REC	40	MDXUSF4218	44
ACZTCHP	13	ATDHDRMOWHWH	34	MDXTBL4836REC	40	MDXUSF4813	44
ACZTCHU	13	ATDVDRMOWHWH	34	MDXTBL4842REC	40	MDXUSF4818	44
ACZTSTP	13	CACPEDFS22BBF	29	MDXTBL4848REC	40	MDXUSF5413	44
ACZTSTU	13	CACPEDFS22FF	29	MDXTBL5424REC	40	MDXUSF5418	44
AKDCNF7236REC	22	CACPEDMO22BBF	29	MDXTBL5430REC	40	MDXUSF6013	44
AKDCNF8442REC	22	CACPEDMO22FF	29	MDXTBL5436REC	40	MDXUSF6018	44
AKDCNF9642REC	22	CACPEDSP22BBF	29	MDXTBL5442REC	40	MDXUSF6613	44
AKDDBB36RND	22	CACPEDSP22FF	29	MDXTBL5448REC	40	MDXUSF6618	44
AKDDBB36SQR	22	CACWRDL56BBF	30	MDXTBL6024REC	41	MDXUSF7213	44
AKDDBB42RND	22	CACWRDL56FF	30	MDXTBL6030REC	41	MDXUSF7218	44
AKDDBB42SQR	22	CACWRDLO56BBF	30	MDXTBL6036REC	41	MOBCARTWLWH	34
AKDDBS36RND	22	CACWRDLO56FF	30	MDXTBL6042REC	41	MPP48WH	23
AKDDBS36SQR	22	CACWRDRD56BBF	30	MDXTBL6048REC	41	MPP60WH	23
AKDDBS42RND	22	CACWRDRD56FF	30	MDXTBL6624REC	41	MPP72WH	23
AKDDBS42SQR	22	CACWRDRO56BBF	30	MDXTBL6630REC	41	MRJLGAU	18
AKDFLP4818REC	20	CACWRDRO56FF	30	MDXTBL6636REC	41	MRJLGBU	18
AKDFLP4824REC	20	CASKIT4	38, 41	MDXTBL6642REC	41	MRJLGLU	18
AKDFLP4830REC	20	CRTSLDSL	25	MDXTBL6648REC	41	MRJLGOU	18
AKDFLP5418REC	20	ECLGCHU	17	MDXTBL7224REC	41	MRJLGRU	18
AKDFLP5424REC	20	ECLMCHU	17	MDXTBL7230REC	41	MRJLGTU	18
AKDFLP5430REC	20	ECLMSTU	17	MDXTBL7236REC	41	PWR110VBL	23, 46
AKDFLP6018REC	20	ECLTCHU	16	MDXTBL7242REC	41	PWR110VWH	23, 46
AKDFLP6024REC	20	FDS1636	26	MDXTBL7248REC	41	PWRDCSL	23, 46
AKDFLP6030REC	20	FDS1648	26	MDXTBL7824REC	41	PWREDGBL	23, 46
AKDFLP6618REC	20	FDS1660	26	MDXTBL7830REC	41	PWREDGWH	23, 46
AKDFLP6624REC	20	FDS1672	26	MDXTBL7836REC	41	PWREXT	23, 46
AKDFLP6630REC	20	FMP48WH	23	MDXTBL7842REC	41	PWRISBL	23, 46
AKDFLP7218REC	20	FMP60WH	23	MDXTBL7848REC	41	PWRISDCBL	23, 46
AKDFLP7224REC	20	FMP72WH	23	MDXTBL8424REC	41	PWRISDCWH	23, 46
AKDFLP7230REC	20	FRSVERTPBBL	34	MDXTBL8430REC	41	PWRISWH	23, 46
AKDFXP4818REC	21	FRSVERTPBWH	34	MDXTBL8436REC	41	PWRUSBACBL	23, 46
AKDFXP4824REC	21	GNG1	23	MDXTBL8442REC	41	PWRUSBACWH	23, 46
AKDFXP4830REC	21	JBEAFB6020REC	24	MDXTBL8448REC	41	SPHRSCWH	34
AKDFXP5418REC	21	JBEAFB6024REC	24	MDXTSH2219REC	42	STRHRDSL	35
AKDFXP5424REC	21	JBEAFB7220REC	24	MDXTSH2519REC	42	STRHRDWH	35
AKDFXP5430REC	21	JBEAFB7224REC	24	MDXTSH2819REC	42	STRRECSL	35
AKDFXP6018REC	21	LULDLPL	25	MDXTSH3119REC	42	STRRECWH	35
AKDFXP6024REC	21	LULDLPSL	25	MDXTSH3419REC	42	UNY01	32
AKDFXP6030REC	21	LULDLPWH	25	MDXTSH3719REC	42	UNY06	33
AKDFXP6618REC	21	MDXDSK3624REC	37	MDXTSH4019REC	42	UNY08	33
AKDFXP6624REC	21	MDXDSK3630REC	37	MDXUFR3625	43	UNY10	33
AKDFXP6630REC	21	MDXDSK3636REC	37	MDXUFR3637	43	UNY11	33
AKDFXP7218REC	21	MDXDSK4224REC	37	MDXUFR4225	43	UNYLOCFS18	32
AKDFXP7224REC	21	MDXDSK4230REC	37	MDXUFR4237	43	UNYLOCFS36	32
AKDFXP7230REC	21	MDXDSK4236REC	37	MDXUFR4825	43	UNYTKCBL	33
AKDFXT4818REC	20	MDXDSK4824REC	38	MDXUFR4837	43	UNYTKCWH	33
AKDFXT4824REC	20	MDXDSK4830REC	38	MDXUFR5425	43	VYBLOCSUGRNTWH	34
AKDFXT4830REC	20	MDXDSK4836REC	38	MDXUFR5437	43	VYBLOCSUGRPTBL	34
AKDFXT5418REC	20	MDXDSK5424REC	38	MDXUFR6025	43		
AKDFXT5424REC	20	MDXDSK5430REC	38	MDXUFR6037	43		
AKDFXT5430REC	20	MDXDSK5436REC	38	MDXUFR6625	43		
AKDFXT6018REC	20	MDXDSK6024REC	38	MDXUFR6637	43		
AKDFXT6024REC	20	MDXDSK6030REC	38	MDXUFR7225	43		
AKDFXT6030REC	20	MDXDSK6036REC	38	MDXUFR7237	43		
AKDFXT6618REC	20	MDXDSK6624REC	38	MDXUMB36	43		
AKDFXT6624REC	20	MDXDSK6630REC	38	MDXUMB42	43		

